



Bronze and Stainless Steel 2-Way Solenoid Valves



sales@qcp-llc.com

...For Reliable Control of
**Water, Oil, Steam, Air, Gas, Cryogenics,
Solvents, Oxygen, and Corrosive Fluids**

AVAILABLE for
QUICK DELIVERY



**Proudly Made
in the USA**



Catalog 3020

WELCOME to MAGNATROL

Process Control Solenoid Valves for
Water • Oil • Air • Gas • Steam • Cryogenics • Vacuum • Solvents
Brine • Oxygen • Corrosive Fluids



Magnatrol Valve Corp.

- Established 1936
- ISO 9001:2015 Certified Quality Management System
- Experienced Dedicated Sales Staff
- Application / Engineering Assistance
- Excellent Product Support
- Quick Delivery

Our continued success has come from manufacturing a top quality product, product support, commitment to service and on-time delivery ensuring complete customer satisfaction.

TABLE OF CONTENTS

Category	Pages(s)
Coils.....	4
Construction Features.....	5
Bronze Valves	
N & NR	6-7
A & AR.....	8-9
M & MR.....	10-11
S & SR	12-13
L & LR	14-15
G & GR	16-17
D.....	18
Strainers.....	19
Stainless Steel Valves	
J & JR.....	20-21
K & KR.....	22-23
W & WR	24-25
Optional Features.....	26-27
Special Valves	
Universal Mount "P".....	28
Sandy Well Water	29
Gritty Coolant	30-31
Ordering Information	32-33
Terms & Conditions/Contact Info	34

OUR PRODUCTS

Every valve is manufactured and tested in-house following Quality Assurance Standards where production operations are under the control of our dedicated, experienced staff and workforce.

- High Quality Bronze and Stainless Steel Solenoid Valves*
- Pressures up to 500 PSI*
- Temperatures up to 400° F*
- Cryogenic and Oxygen Service Applications
- Normally Closed (Energize to Open)
- Normally Open (Energize to Close)
- Continuous Duty Coils for all AC & DC Voltages
- NO Differential Pressure Required to Open
- Full Port-Internal Pilot Operated or Direct Acting
- 2-Way Straight Thru Design
- Packless Construction

***Custom engineered valves,** special alloys, temperatures, pressures and applications as well as modifications to standard Magnatrol valves are available through Magnatrol's **Clark-Cooper Division.**
(See bottom of page 3)

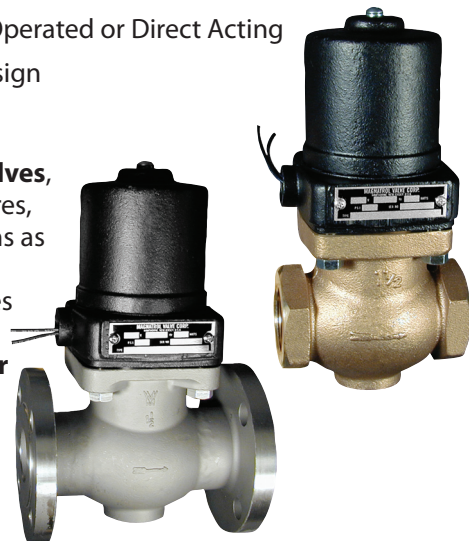

VALVE SELECTION CHART



Ordering Information - See Pages 32 & 33
For Optional Features - See Pages 26 & 27

For Fluids/Gases Not Listed
 and for Special Applications,
 Consult Factory

Use the chart below to determine suitable types of Magnatrol valves for a given application.

Example: A normally closed 1/2" valve for use on 100 psi steam, there are four types suitable and the final selection can only be made after referring to Bulletins 3020-M, 3020-S, 3020-J and 3020-W on pages 10, 12, 20 and 24 respectively.

Maximum Differential Pressure:

When specifying a valve, the Maximum Differential Pressure must be equal to or greater than the application. Care should be taken not to "over specify" the valve by choosing a valve with a Maximum Differential Pressure that is excessively beyond the application.

If you are unsure please consult the factory.

Max. Temperature	Up To 212°F							Up To 400°F		
Construction	Bronze							Stainless Steel		
Valve Type	D	G/GR	N/NR	A/AR	M/MR	S/SR	L/LR	J/JR	K/KR	W/WR
Page	18	16 & 17	6 & 7	8 & 9	10 & 11	12 & 13	14 & 15	20 & 21	22 & 23	24 & 25
Max. Diff. Pressure	30 PSI	50 PSI	300 PSI	500 PSI	150 PSI	180 PSI	500 PSI	300 PSI	500 PSI	180 PSI
Pipe Size Inches	3/8"-2"	1"-3"	1/2"-3/4"	1/2"-3"	3/8"-3/4"	1/2"-3"	1/2"-3"	3/8"-1/2"	1/2"-3"	1/2"-3"
Internal Port Size	Full	Full	Reduced	Full	Reduced	Full	Full	Reduced	Full	Full
Air	◆	◆	◆	◆	◆		◆	◆	◆	
Brine			◆	◆	◆		◆	◆	◆	
Gas	◆	◆	◆	◆	◆		◆	◆	◆	
Oil	◆	◆	◆	◆	◆		◆	◆	◆	
Solvents	◆	◆	◆	◆	◆		◆	◆	◆	
Water	◆	◆	◆	◆	◆		◆	◆	◆	
Vacuum	◆	◆	◆							
Steam					◆	◆		◆		◆
Cryogenic					◆		◆	◆	◆	
Oxygen, Liquid					◆		◆	◆	◆	
Oxygen, Gaseous	◆	◆		◆			◆		◆	
Corrosive								◆	◆	

FOR CUSTOM ENGINEERED VALVES, MODIFICATIONS TO STANDARD MAGNATROL VALVES AND VALVES THAT FALL OUTSIDE OUR STANDARD VALVE CAPABILITIES, CONTACT MAGNATROL'S CLARK COOPER DIVISION

- PRESSURES TO 15,000 PSI
- FLUID TEMPERATURES UP TO 550°F
- DIRTY/VISCOUS & CORROSIVE FLUIDS
- MANY OPTIONS FOR END CONNECTIONS, REMOTE TRIP AND MANY OTHERS



CLARK COOPER
 941 HAMILTON AVE
 ROEBLING NJ 08554

WWW.CLARKCOOPER.COM
 PHONE: 856-829-4580
 EMAIL: INFO@CLARKCOOPER.COM

SOLENOID COILS

CONTINUOUS DUTY COILS

ENCAPSULATED COIL

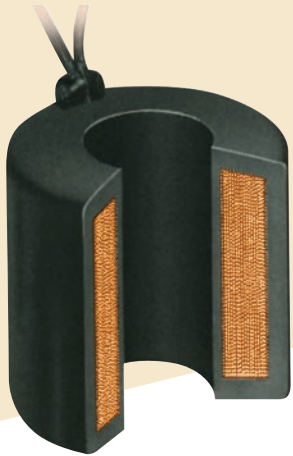

ELECTRICAL CHARACTERISTICS:

Coils are stocked for the following voltages:

Voltage	6	12	24	32	48	64	75	120	208	240	480	575
50, 60 Hertz AC		
DC	*		*		

75V DC for locomotive applications

*Furnished with surge protecting capacitor

Reference should be made to the Bulletins to determine the availability of a required valve for a specific power supply.

Consult the factory for information regarding voltage and frequencies not listed.

Valves for AC service can be converted for use on other AC voltages simply by changing the coil. Similarly DC valves can be converted for other DC voltages. Consult factory regarding conversion from AC to DC or DC to AC.

INSTALLATION:

The coil is a two wire device which may be controlled by either a single or double pole switch. The switch should always be installed in the hot leg of 120 volt circuits. Where both legs are hot, such as 240 or 480 volt circuits, a double pole switch is preferable, however, if a single pole switch is used, then the wiring should have top quality insulation since even minute leakage currents may give rise to sticking problems. On motor hookup with step control starter, full voltage should be supplied to coil immediately.

Note: Coil can be readily changed while valve is still under pressure.

CURRENT CONSUMPTION:

Current values shown in the bulletins are for 120 volts, 60 hertz. For other voltages the current is inversely proportional: For instance, if a given valve draws 0.5 amperes on 120 volts it would draw 0.25 amperes on 240 volts, or 0.125 amperes on 480 volts. Where power consumption is shown in DC watts, the values given should be divided by line voltage to obtain the current in amperes. Power consumption for all valves is shown in the individual bulletins.

CONSTRUCTION:

Continuous Duty Construction: Coils can be energized continuously without overheating or failure.

Wire Leads: 18" long 18 gauge wire standard (longer continuous leads available)

Encapsulated: Coils are encapsulated for temperature of intended service, providing excellent resistance to shock, moisture, oil and chemicals.

COIL CLASS:

GENERAL SERVICE - CLASS "B"		HIGH TEMPERATURE - CLASS "H"	
Maximum Fluid Temperature	Maximum Ambient Temperature	Maximum Fluid Temperature	Maximum Ambient Temperature
212° F (100° C)	104° F (40° C)	400° F (206° C)	212° F (100° C)

Easy In-Line Service

Inspect, clean or service all internal parts while the valve body remains in the pipeline shortening costly down time and increasing productivity.

VALVE Construction Features

- 2-way straight thru globe design
- Bronze or Stainless Steel body w/female NPT threads standard
- Flanged Ends available on request
- Full port-internal pilot operated or direct acting
- Packless construction
- Continuous duty coils for all voltages
- No differential pressure required to open

MAGNATROL SOLENOID OPERATED VALVES are used to control the flow of liquids or gases, generally in conjunction with automatic control apparatus such as thermostat, float switch, time switch, or flow meter.

HOUSING

- Construction: Malleable or Cast Iron
- Designed for rugged industrial use
- 1/2" NPS conduit connection
- Available: NEMA 12, 4, 4X and Explosion Proof

COIL

- Available Class "B" or "H" insulation
- Designed for continuous duty service
- Available in most AC or DC voltages

BONNET

- A flanged metallic tube encloses the plunger and hermetically seals the top of the valve

PISTON ASSEMBLY

- A sturdily constructed stem assembly consisting of a plunger and stainless steel pilot flexibly connected to the piston
- Discs are available in various materials dictated by operating conditions

VALVE BODY

- Constructed of high pressure cast bronze or stainless steel in a globe pattern
- Available in a full range of sizes

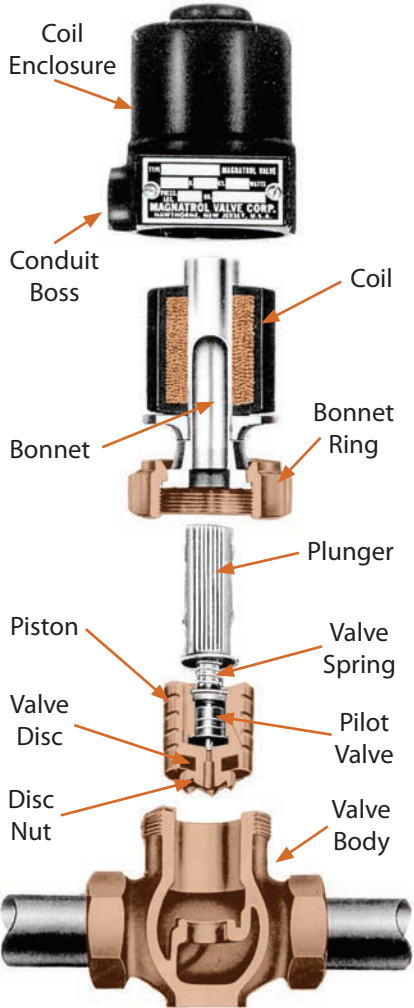
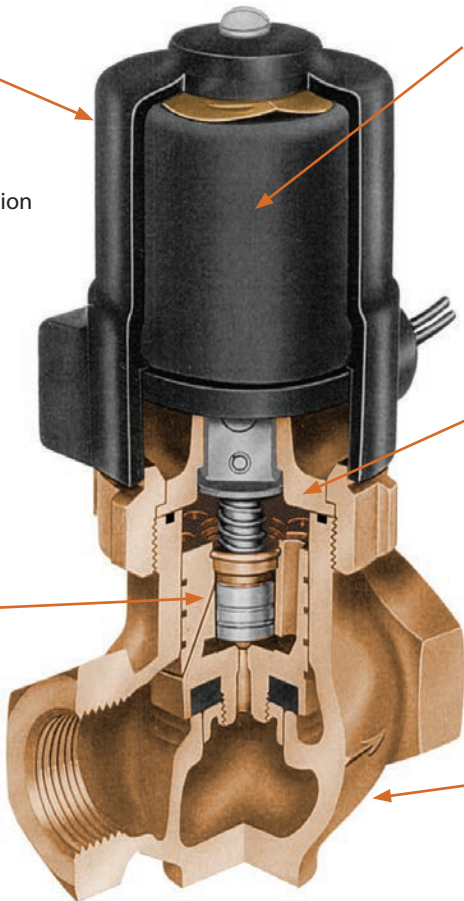

Normally Closed Valve shown is typical of Type A, 1/2" thru 1-1/4"

BULLETIN 3020-N

MAX. FLUID TEMP. 212° F
MAX. STATIC PRESSURE 300 PSI



For Options and Accessories see pages 26 & 27. Strainers are recommended for use with solenoid valves (see page 19).

BRONZE Solenoid Valves

TYPE N **NORMALLY CLOSED - 1/2" to 3/4" PIPE SIZE**
(NO DIFFERENTIAL PRESSURE REQUIRED TO OPEN)

OPERATION:

This **Direct Acting Valve** opens when energized and closes when de-energized. When the coil is energized, the stem is lifted from its conical seat by the plunger. **Direct Acting Orifice Sizes** – 3/32" to 1/2"

CONSTRUCTION: * Wetted parts

- Valve Body* – Cast Bronze, Globe Pattern – NPT ends
- Coil Enclosure – Malleable Iron, 1/2" NPS conduit conn.
- Plunger* – 430 Stainless Steel
- Valve Stem* – 303 Stainless Steel
- Bonnet Tube* – 304 Stainless Steel
- Spring* – 302 Stainless Steel
- Body Seal* – Buna N (Viton® available)
- Orifice Seal* – Metal to Metal (Soft Seat available)
- AC Shading Coil* – Copper
- Stem Pin* – Inconel
- Coil – Encapsulated Class B, 18" leads – (Class H available)

APPLICATION:

To control the flow of **Water, Oil, Air, Gas, Solvents, Brine, Vacuum** and any other fluids not reactive with construction materials and free of sediment. Valve operates from zero to maximum differential pressure indicated in table. Valve must be mounted in horizontal pipe with solenoid enclosure vertical and on top.

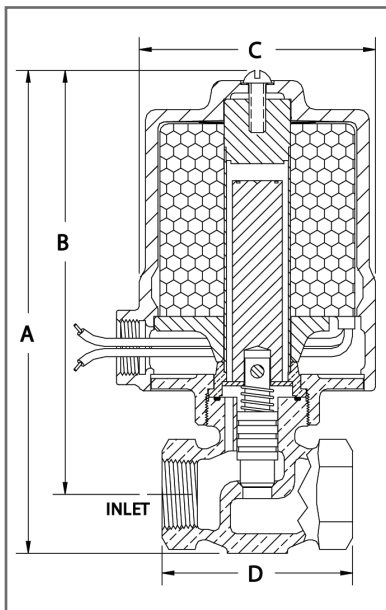

When ordering please supply:

- Pipe Size
- Valve Type
- Voltage (AC or DC)
- Hertz
- Fluid
- Fluid Temperature
- Max. Diff. Pressure
- Optional Features (See pages 26 & 27)

Pipe Size Inches	Max. Diff. PSI	Valve Port Size	Type No.	Watts AC	Amps Hold 120-60	Amps Inrush 120-60	Watts DC	Ship Wt. Lbs.	Dimensions in Inches			
									A	B	C	D
3/8	DISCONTINUED – USE 1/2" VALVE WITH BUSHING											
1/2	25	3/8	18N22	25	0.4	1.2	18	6	6-1/4	5-3/8	2-3/4	2-3/4
	50	1/4	18N42									
	75	3/16	18N52									
	100	5/32	18N82									
	150	1/8	18N62									
	225	3/32	18N72									
3/4	50	3/8	33N22	45	0.8	2.4	23	10	7-1/8	6-3/8	3-1/2	2-3/4
	75	5/16	33N32									
	100	1/4	33N42									
	150	3/16	33N52									
	300	1/8	33N62									
	15	1/2	18N13									
35	5/16	18N33										
30	1/2	33N13	45	0.8	2.5	23	10	7-3/8	6-1/2	3-1/2	2-7/8	
75	5/16	33N33										

Optional Viton® "Soft Seat" Orifice Seal

- For applications requiring tight seating
- Suitable for Fuel Oils, Gaseous Oxygen and other compatible fluids

BRONZE Solenoid Valves



MAX. FLUID TEMP. 212° F
MAX. STATIC PRESSURE 300 PSI

TYPE NR **NORMALLY OPEN - 1/2" to 3/4" PIPE SIZE**
 (NO DIFFERENTIAL PRESSURE REQUIRED TO OPEN)

OPERATION:

This **Direct Acting Valve** closes when energized and opens when de-energized. When the coil is energized, the stem is pressed into its conical seat by the plunger.

Direct Acting Orifice Sizes – 3/32" to 1/2"

CONSTRUCTION: *Wetted parts

- Valve Body* – Cast Bronze, Globe Pattern – NPT ends
- Coil Enclosure – Malleable Iron, 1/2" NPS conduit conn.
- Plunger* – 430 Stainless Steel
- Poppet* – 304 Stainless Steel
- Stem* – 303 Stainless Steel
- Bonnet Tube* – 304 Stainless Steel
- Spring* – Inconel
- Body Seal* – Buna N (Viton® available)
- Orifice Seal* – Metal to Metal (Soft Seat available)
- AC Shading Coil* – Copper
- Stem Pin* – 304 Stainless Steel
- Coil – Encapsulated Class B, 18" leads – (Class H available)

APPLICATION:

To control the flow of **Water, Oil, Air, Gas, Solvents, Brine, Vacuum** and any other fluids not reactive with construction materials and free of sediment. Valve operates from zero to maximum differential pressure indicated in table. Valve must be mounted in horizontal pipe with solenoid enclosure vertical and on top.

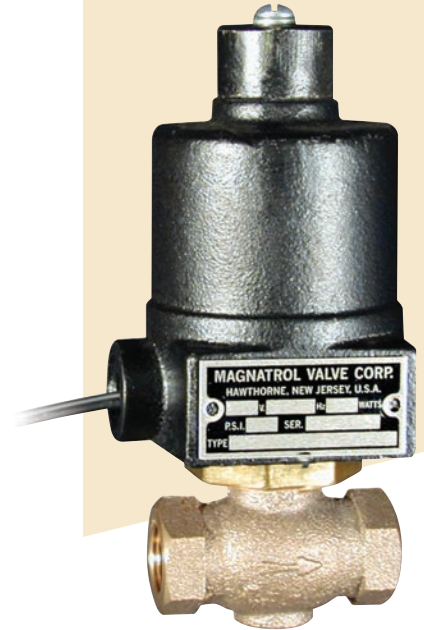

For Options and Accessories see pages 26 & 27. Strainers are recommended for use with solenoid valves (see page 19).

Pipe Size Inches	Max. Diff. PSI	Valve Port Size	Type No.	Watts AC	Amps Hold 120-60	Amps Inrush 120-60	Watts DC	Ship Wt. Lbs.	Dimensions in Inches			
									A	B	C	D
3/8	DISCONTINUED – USE 1/2" VALVE WITH BUSHING											
1/2	23	3/8	18NR22	25	0.5	1.5	18	7	7	6-1/8	2-3/4	2-3/4
	45	1/4	18NR42									
	70	3/16	18NR52									
	90	5/32	18NR82									
	135	1/8	18NR62									
	200	3/32	18NR72									
1/2	45	3/8	33NR22	45	1.0	2.7	23	10	7-7/8	7-1/8	3-1/2	2-3/4
	70	5/16	33NR32									
	90	1/4	33NR42									
	135	3/16	33NR52									
	270	1/8	33NR62									
3/4	13	1/2	18NR13	25	0.5	1.6	18	7	7-1/4	6-3/8	2-3/4	2-7/8
	32	5/16	18NR33									
	27	1/2	33NR13									
	70	5/16	33NR33									

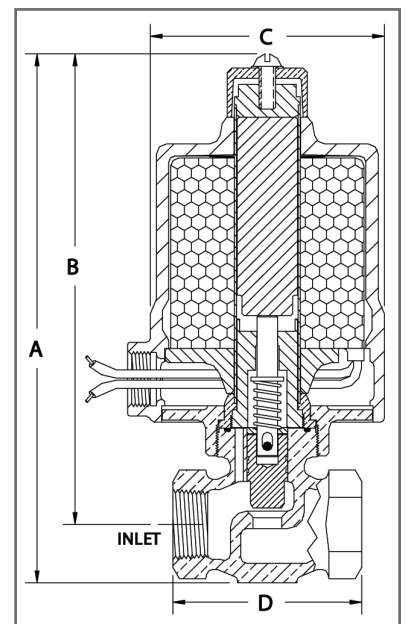

- When ordering please supply:**
- Pipe Size
 - Valve Type
 - Voltage (AC or DC)
 - Hertz
 - Fluid
 - Fluid Temperature
 - Max. Diff. Pressure
 - Optional Features (See pages 26 & 27)

Optional Viton® "Soft Seat" Orifice Seal – For applications requiring tight seating
 – Suitable for Fuel Oils, Gaseous Oxygen and other compatible fluids

BULLETIN 3020-A

BRONZE Solenoid Valves

MAX. FLUID TEMP. 212° F
 MAX. STATIC PRESSURE 300 PSI
 (Except valves listed for 500 PSI)



For Options and Accessories see pages 26 & 27. Strainers are recommended for use with solenoid valves (see page 19).

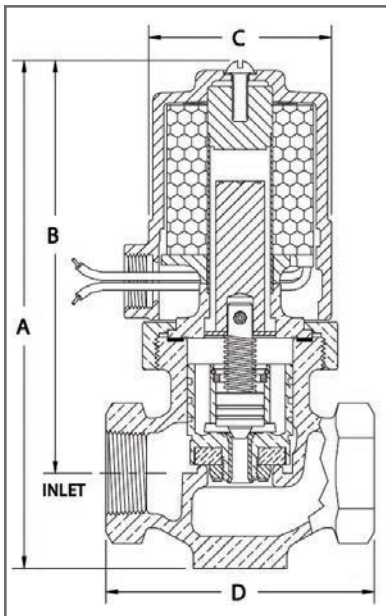

When ordering please supply:

- Pipe Size
- Valve Type
- Voltage (AC or DC)
- Hertz
- Fluid
- Fluid Temperature
- Max. Diff. Pressure
- Optional Features (See pages 26 & 27)

TYPE A FULL PORT NORMALLY CLOSED - 1/2" to 3" PIPE SIZE

(NO DIFFERENTIAL PRESSURE REQUIRED TO OPEN)

OPERATION: Valve opens when energized and closes when de-energized. When the coil is energized the pilot valve opens, relieving the pressure above the piston, which is then lifted from its seat by the plunger. Upon de-energizing the coil, a spring closes the pilot valve and opens a bleed passageway to permit pressure to build above the piston and seat it.

CONSTRUCTION: *Wetted parts

- Valve Body* – Cast Bronze, Globe Pattern – NPT ends (Flanged Ends available)
- Piston* – Bronze
- Coil Enclosure – Malleable or Cast Iron, 1/2" NPS conduit conn.
- Plunger* – 430 Stainless Steel
- Pilot Valve* – 303 Stainless Steel
- Bonnet Tube* – 304 Stainless Steel
- Spring* – 302 Stainless Steel
- Body Seal* – Buna N or Non Asbestos Gasket (Viton® or Teflon® available)
- Orifice Seal* – Buna N (Viton® or Glass Filled Teflon® available)
- AC Shading Coil* – Copper
- Stem Pin* – Inconel
- Coil – Encapsulated Class B, 18" leads – (Class H available)

APPLICATION: To control the flow of Water, Oil, Air, Gas, Solvents, Brine, Vacuum and any other fluids not reactive with construction materials and free of sediment. Valve operates from zero to maximum differential pressure indicated in table. Valve must be mounted in horizontal pipe with solenoid enclosure vertical and on top.

Pipe Size Inches	Max. Diff. PSI	Type No.	Watts AC	Amps Hold 120-60	Amps Inrush 120-60	Watts DC	Ship Wt. Lbs.†	Dimensions in Inches				
								A*	B	C	D	D (Flanged) 150#
1/2	110	18A42	25	0.4	1.2	18	8	7	5-7/8	2-3/4	3-1/4	4-3/4
	200	18A32										N/A
	300	18A52	45	0.8	2.4	23	16	8	6-7/8	4-1/8	3-1/4	N/A
	500	E33A62										N/A
3/4	50	18A23	25	0.4	1.3	18	8	7-1/8	6	2-3/4	3-1/2	5-1/2
	110	18A43										N/A
	160	118A43	40	0.6	2.0	28	12	8-1/8	7	3-1/2	3-1/2	5-1/2
	200	33A33										N/A
	300	33A53	45	0.8	2.6	23	17	8-1/8	7	4-1/8	3-1/2	N/A
	500	E133A63										N/A
1	50	18A24	25	0.4	1.5	18	10	7-7/8	6-5/8	2-3/4	4-1/8	5
	110	18A44										N/A
	160	118A44	40	0.6	2.3	28	14	8-7/8	7-1/2	4-1/8	4-1/8	5
	200	33A34										N/A
	300	33A54	45	0.8	2.8	23	19	8-7/8	7-1/2	4-1/8	4-1/8	N/A
	500	E133A64										N/A
1-1/4	50	18A25	25	0.4	1.6	18	12	8-3/8	6-3/4	2-3/4	4-1/2	7
	90	18A45										N/A
	150	118A45	40	0.6	2.4	28	16	9-3/8	7-3/4	3-1/2	4-1/2	7
	200	33A35										N/A
	300	33A55	45	0.8	3.0	23	20	10-3/8	8-3/4	4-1/2	4-1/2	N/A
	500	† 40A65										N/A
1-1/2	50	35A26	45	0.8	3.2	23	20	10	8-1/8	4	4-7/8	7-3/4
	115	35A46										N/A
	160	135A46	65	1.2	4.8	33	24	11	9-1/8	4-1/2	4-7/8	7-3/4
	200	41A36										N/A
	300	41A56	60	1.2	6.7	35	45	11	9-1/8	4-1/2	4-7/8	N/A
	500	141A66										N/A
2	50	36A27	45	0.8	3.5	23	31	11	8-3/4	5-3/8	6	8
	100	36A47										N/A
	150	136A47	65	1.2	5.0	33	36	12	9-3/4	5-3/8	6	8
	200	42A37										N/A
	300	42A57	60	1.2	7.4	35	45	12	9-3/4	5-3/8	6	N/A
	500	142A67										N/A
2-1/2	50	43A28	60	1.2	8.0	35	43	12-7/8	10-1/8	5-7/8	7-1/4	11
	125	43A48										N/A
	200	43A38	85	2.0	12.0	45	56	13-3/4	10-1/2	6-5/8	8-3/8	11
	300	143A58										N/A
3	50	44A29	60	1.2	8.8	35	56	13-3/4	10-1/2	6-5/8	8-3/8	9-1/2
	100	44A49										N/A
	200	44A39	85	2.0	13.0	45	56	13-3/4	10-1/2	6-5/8	8-3/8	9-1/2
	300	144A59										N/A

† Not available for DC operation ♦ Shipping weights and Dimension "A" apply to NPT Ends

BRONZE Solenoid Valves



MAX. FLUID TEMP. 212° F
MAX. STATIC PRESSURE 300 PSI
 (Except valves listed for 500 PSI)

TYPE AR FULL PORT NORMALLY OPEN - 1/2" to 3" PIPE SIZE (NO DIFFERENTIAL PRESSURE REQUIRED TO OPEN)

OPERATION: Valve closes when energized and opens when de-energized. When the coil is energized the plunger presses the poppet, closing the pilot orifice, and opens a bleed passageway to permit pressure to build above the piston and seat it. Upon de-energizing the coil, the pilot orifice is opened, relieving the pressure above the piston allowing it to leave its seat. The bottom spring allows the valve to operate at zero pressure drop.

CONSTRUCTION: *Wetted parts

- Valve Body* – Cast Bronze, Globe Pattern – NPT ends (Flanged Ends available)
- Piston* – Bronze
- Coil Enclosure – Malleable or Cast Iron, 1/2" NPS conduit conn.
- Plunger* – 430 Stainless Steel
- Pilot Valve* – 303 Stainless Steel
- Bonnet Tube* – 304 Stainless Steel
- Spring* – 302 Stainless Steel
- Body Seal* – Buna N or Non Asbestos Gasket (Viton® or Teflon® available)
- Orifice Seal* – Buna N (Viton® or Glass Filled Teflon® available)
- AC Shading Coil* – Copper
- Stem Pin* – Inconel
- Coil – Encapsulated Class B, 18" leads – (Class H available)

APPLICATION: To control the flow of Water, Oil, Air, Gas, Solvents, Brine, Vacuum and any other fluids not reactive with construction materials and free of sediment. Valve operates from zero to maximum differential pressure indicated in table. Valve must be mounted in horizontal pipe with solenoid enclosure vertical and on top.

Pipe Size Inches	Max. Diff. PSI	Type No.	Watts AC	Amps Hold 120-60	Amps Inrush 120-60	Watts DC	Ship Wt. Lbs.*	Dimensions in Inches													
								A†	B	C	D	D (Flanged) 150#									
1/2	110	18AR42	25	0.5	1.5	18	8	8-1/8	7	2-3/4	3-1/4	4-3/4									
	200	18AR32										N/A									
	300	18AR52										N/A									
	500	E33AR62										45	1.0	2.7	23	16	9-3/8	8-1/4	4-1/8	3-1/4	N/A
3/4	50	18AR23	25	0.5	1.6	18	9	8-1/4	7-1/8	2-3/4	3-1/2	5-1/2									
	110	18AR43										N/A									
	200	33AR33										45	1.0	2.9	23	13	9-1/4	8-1/8	3-1/2	3-1/2	N/A
	300	33AR53										45	1.0	2.9	23	13	9-1/4	8-1/8	3-1/2	3-1/2	N/A
1	50	18AR24	25	0.5	1.8	18	11	9	7-3/4	2-3/4	4-1/8	5									
	110	18AR44										N/A									
	200	33AR34										45	1.0	3.0	23	14	10	8-5/8	3-1/2	4-1/8	N/A
	300	33AR54										45	1.0	3.0	23	14	10	8-5/8	3-1/2	4-1/8	N/A
1-1/4	50	18AR25	25	0.5	1.9	18	13	9-3/4	8-1/8	2-3/4	4-1/2	7									
	90	18AR45										N/A									
	200	33AR35										45	1.0	3.2	23	17	10-3/4	9-1/8	3-1/2	4-1/2	N/A
	300	33AR55										45	1.0	3.2	23	17	10-3/4	9-1/8	3-1/2	4-1/2	N/A
1-1/2	50	40AR65	60	1.7	6.2	N/A	21	11	9-3/8	4-1/2	4-1/2	N/A									
	50	35AR26	45	1.0	3.8	23	21	11-3/8	9-1/2	4	4-7/8	7-3/4									
	115	35AR46										N/A									
	200	41AR36										60	1.7	6.5	35	25	11-5/8	9-3/4	4-1/2	4-7/8	N/A
300	41AR56	60										1.7	6.5	35	25	11-5/8	9-3/4	4-1/2	4-7/8	N/A	
2	50	141AR66	85	3.5	9.7	45															
	100	36AR27	45	1.0	4.2	23	31	12-3/8	10-1/8	5-3/8	6	8									
	200	42AR37										60	1.7	7.3	35	36	12-5/8	10-3/8	5-3/4	6	N/A
	300	42AR57										60	1.7	7.3	35	36	12-5/8	10-3/8	5-3/4	6	N/A
500	142AR67	85										3.5	11.0	45							
2-1/2	50	43AR28	60	1.7	8.0	35	45	13-1/2	10-3/4	5-7/8	7-1/4	11									
	125	43AR48										N/A									
	200	43AR38										N/A									
	300	143AR58										85	3.5	13.0	45						
3	50	44AR29	60	1.7	8.8	35	57	14-3/8	11-1/8	6-5/8	8-3/8	9-1/2									
	100	44AR49										N/A									
	200	44AR39										N/A									
	300	144AR59										85	3.5	13.0	45						

† Not available for DC operation ♦ Shipping weights and Dimension "A" apply to NPT Ends



For Options and Accessories see pages 26 & 27. Strainers are recommended for use with solenoid valves (see page 19).

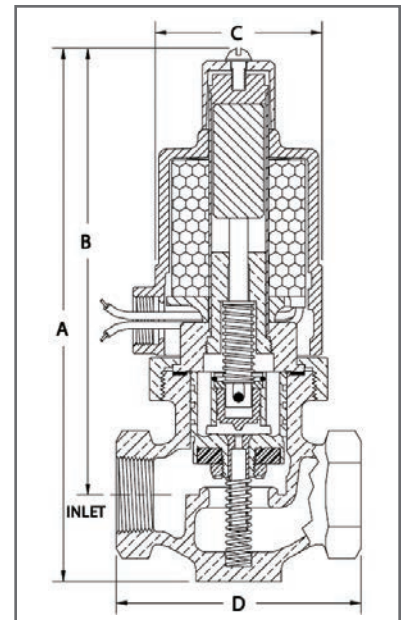

- When ordering please supply:**
- Pipe Size
 - Valve Type
 - Voltage (AC or DC)
 - Hertz
 - Fluid
 - Fluid Temperature
 - Max. Diff. Pressure
 - Optional Features (See pages 26 & 27)

BULLETIN 3020-M

MAX. FLUID TEMP. 400° F
MAX. STATIC PRESSURE 150 PSI



For Options and Accessories see pages 26 & 27. Strainers are recommended for use with solenoid valves (see page 19).

BRONZE Solenoid Valves

TYPE M NORMALLY CLOSED - 3/8" to 3/4" PIPE SIZE
(NO DIFFERENTIAL PRESSURE REQUIRED TO OPEN)

OPERATION: Valve opens when energized and closes when de-energized. In this direct acting valve, when the coil is energized, the stem is lifted from its conical seat by the plunger. Direct Acting Orifice Sizes – 1/8" to 1/2"

CONSTRUCTION: *Wetted parts

- Valve Body* – Cast Bronze, Globe Pattern – NPT ends
- Coil Enclosure – Malleable Iron, 1/2" NPS conduit conn.
- Plunger* – 430 Stainless Steel
- Valve Stem* – 303 Stainless Steel
- Bonnet Tube* – 304 Stainless Steel
- Spring* – Inconel
- Body Seal* – Non Asbestos Gasket (Teflon® available)
- Orifice Seal* – Metal to Metal (Soft Seat available)
- AC Shading Coil* – Copper
- Stem Pin* – Inconel
- Coil – Encapsulated Class H, 18" leads

APPLICATION: To control the flow of Steam, Hot Liquids, Hot Gases, Cryogenics** and any other fluids not reactive with construction materials and free of sediment. Cryogenic fluids include Liquid Oxygen (-297°F), Liquid Argon (-303°F) and Liquid Nitrogen (-320°F). Valve operates from zero to maximum differential pressure indicated in table. Valve must be mounted in horizontal pipe with solenoid enclosure vertical and on top.

- **Cleaning** – Cryogenic valves are degreased and cleaned to keep them free of moisture.
– Oxygen valves are also "black light" tested.

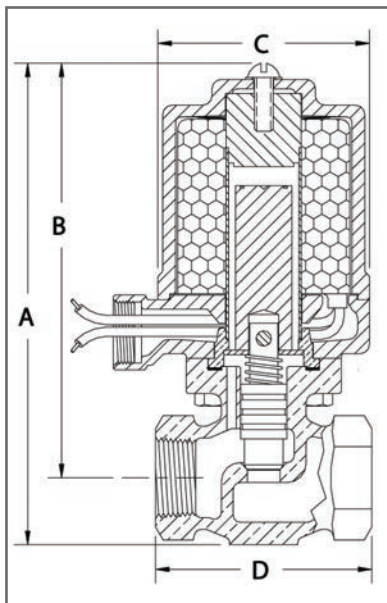

When ordering please supply:

- Pipe Size
- Valve Type
- Voltage (AC or DC)
- Hertz
- Fluid
- Fluid Temperature
- Max. Diff. Pressure
- Optional Features (See pages 26 & 27)

Pipe Size Inches	Max. Diff. PSI	Valve Port Size	Type No.	Watts AC	Amps Hold 120-60	Amps Inrush 120-60	Watts DC	Ship Wt. Lbs.	Dimensions in Inches												
									A	B	C	D									
3/8	25	3/8	10M21	25	0.4	1.1	18	6	6-1/4	5-1/2	2-7/8	2-5/8									
	50	1/4	10M41																		
	75	3/16	10M51																		
	100	5/32	10M81																		
	150	1/8	10M61																		
	50	3/8	25M21										45	0.8	2.3	23	10	7-1/8	6-3/8	3-1/2	2-5/8
75	5/16	25M31																			
100	1/4	25M41																			
150	3/16	25M51																			
1/2	25	3/8	10M22	25	0.4	1.2	18	6	6-1/4	5-1/2	2-7/8	2-3/4									
	50	1/4	10M42																		
	75	3/16	10M52																		
	100	5/32	10M82																		
	150	1/8	10M62																		
	50	3/8	25M22										45	0.8	2.4	23	10	7-1/8	6-3/8	3-1/2	2-3/4
75	5/16	25M32																			
100	1/4	25M42																			
150	3/16	25M52																			
3/4	15	1/2	10M13	25	0.4	1.3	18	7	6-1/2	5-5/8	2-7/8	2-7/8									
	35	5/16	10M33																		
	30	1/2	25M13										45	0.8	2.5	23	10	7-3/8	6-1/2	3-1/2	2-7/8
	75	5/16	25M33																		

Optional Viton® "Soft Seat" Orifice Seal

- For applications requiring tight seating
- Suitable for Fuel Oils, Gaseous Oxygen and other compatible fluids

BRONZE Solenoid Valves



MAX. FLUID TEMP. 400° F
MAX. STATIC PRESSURE 150 PSI

TYPE MR NORMALLY OPEN - 3/8" to 3/4" PIPE SIZE (NO DIFFERENTIAL PRESSURE REQUIRED TO OPEN)

OPERATION: Valve closes when energized and opens when de-energized. In this direct acting valve, when the coil is energized, the stem is pressed into its conical seat by the plunger.
Direct Acting Orifice Sizes – 1/8" to 1/2"

CONSTRUCTION: *Wetted parts

- Valve Body* – Cast Bronze, Globe Pattern – NPT ends
- Coil Enclosure – Malleable Iron, 1/2" NPS conduit conn.
- Plunger* – 430 Stainless Steel
- Poppet* – 304 Stainless Steel
- Stem* – 303 Stainless Steel
- Bonnet Tube* – 304 Stainless Steel
- Spring* – Inconel
- Body Seal* – Non Asbestos Gasket (Teflon® available)
- Orifice Seal* – Metal to Metal (Soft Seat available)
- AC Shading Coil* – Copper
- Stem Pin* – Inconel
- Coil – Encapsulated Class H, 18" leads

APPLICATION: To control the flow of **Steam, Hot Liquids, Hot Gases, Cryogenics**** and any other fluids not reactive with construction materials and free of sediment. Cryogenic fluids include Liquid Oxygen (-297°F), Liquid Argon (-303°F) and Liquid Nitrogen (-320°F). Valve operates from zero to maximum differential pressure indicated in table. Valve must be mounted in horizontal pipe with solenoid enclosure vertical and on top.

****Cleaning** – Cryogenic valves are degreased and cleaned to keep them free of moisture.
– Oxygen valves are also "black light" tested.

Pipe Size Inches	Max. Diff. PSI	Valve Port Size	Type No.	Watts AC	Amps Hold 120-60	Amps Inrush 120-60	Watts DC	Ship Wt. Lbs.	Dimensions in Inches												
									A	B	C	D									
3/8	23	3/8	10MR21	25	0.5	1.4	18	7	7	6-1/4	2-7/8	2-5/8									
	45	1/4	10MR41																		
	70	3/16	10MR51																		
	90	5/32	10MR81																		
	135	1/8	10MR61																		
	45	3/8	25MR21										45	1.0	2.6	23	10	7-7/8	7-1/8	3-1/2	2-5/8
70	5/16	25MR31																			
90	1/4	25MR41																			
135	3/16	25MR51																			
45	3/8	25MR22	25	0.5	1.5	18	7	7	6-1/4	2-7/8	2-3/4										
70	1/4	10MR42																			
90	3/16	10MR52																			
135	5/32	10MR82																			
45	3/8	25MR22																			
70	5/16	25MR32																			
90	1/4	25MR42	45	1.0	2.7	23	10	7-7/8	7-1/8	3-1/2	2-3/4										
135	3/16	25MR52																			
3/4	13	1/2										10MR13	25	0.5	1.6	18	7	7-1/4	6-3/8	2-7/8	2-7/8
	32	5/16										10MR33									
	27	1/2	25MR13																		
	70	5/16	25MR33																		

Optional Viton® "Soft Seat" Orifice Seal

- For applications requiring tight seating
- Suitable for Fuel Oils, Gaseous Oxygen and other compatible fluids



For Options and Accessories see pages 26 & 27. Strainers are recommended for use with solenoid valves (see page 19).

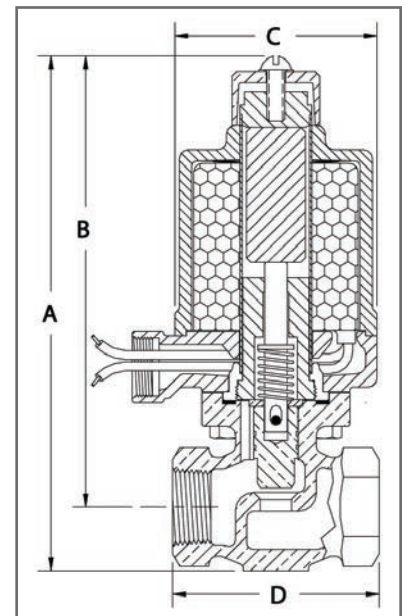

- When ordering please supply:**
- Pipe Size
 - Valve Type
 - Voltage (AC or DC)
 - Hertz
 - Fluid
 - Fluid Temperature
 - Max. Diff. Pressure
 - Optional Features (See pages 26 & 27)

BULLETIN 3020-S

BRONZE Solenoid Valves

MAX. FLUID TEMP. 400° F
MAX. STATIC PRESSURE 200 PSI

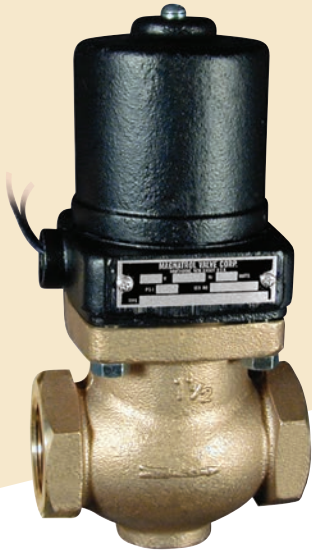

TYPE S FULL PORT NORMALLY CLOSED - 1/2" to 3" PIPE SIZE (NO DIFFERENTIAL PRESSURE REQUIRED TO OPEN)

OPERATION:

Valve opens when energized and closes when de-energized. When the coil is energized the pilot valve opens, relieving the pressure above the piston, which is then lifted from its seat by the plunger. Upon de-energizing the coil, a spring closes the pilot valve and opens a bleed passageway to permit pressure to build above the piston and seat it.

CONSTRUCTION: *Wetted parts

- Valve Body* - Cast Bronze, Globe Pattern - NPT ends (**Flanged Ends available**)
- Piston* - Bronze
- Coil Enclosure - Malleable or Cast Iron, 1/2" NPS conduit conn.
- Plunger* - 430 Stainless Steel
- Pilot Valve* - 303 Stainless Steel
- Bonnet Tube* - 304 Stainless Steel
- Spring* - Inconel
- Body Seal* - Non Asbestos Gasket (**Teflon® available**)
- Orifice Seal* - Glass Filled Teflon®
- AC Shading Coil* - Copper
- Stem Pin* - Inconel
- Coil - Encapsulated Class H, 18" leads

APPLICATION:

To control the flow of **Steam**. Steam must be free of sediment. Valve operates from zero to maximum differential pressure indicated in table. Valve must be mounted in horizontal pipe with solenoid enclosure vertical and on top.

For Options and Accessories see pages 26 & 27. Strainers are recommended for use with solenoid valves (see page 19).

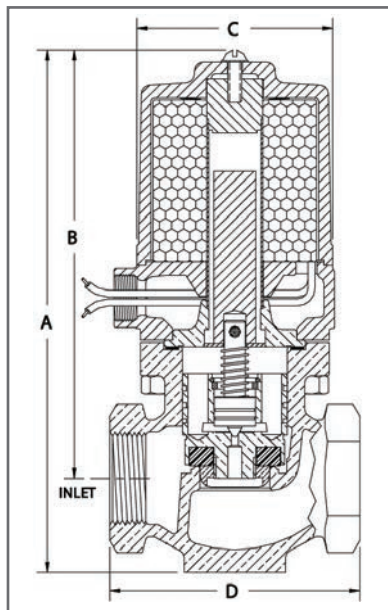

Pipe Size Inches	Max. Diff. PSI	Type No.	Watts AC	Amps Hold 120-60	Amps Inrush 120-60	Watts DC	Ship Wt. Lbs.+	Dimensions in Inches				
								A*	B	C	D	D (Flanged) 150#
1/2	90	14S22	25	0.4	1.2	18	8	7	5-7/8	2-7/8	3-1/4	4-3/4
	140	114S42	40	0.6	1.8	28						
	180	129S42	65	1.2	3.6	33	11	8	6-7/8	3-1/2	3-1/4	N/A
3/4	50	14S23	25	0.4	1.3	18	9	7-1/8	6	2-7/8	3-1/2	5-1/2
	110	114S43	40	0.6	2.0	28						
1	180	129S43	65	1.2	3.9	33	12	8-1/8	7	3-1/2	3-1/2	N/A
	25	16S14	25	0.4	1.5	18						
1	50	116S24	40	0.6	2.3	28	11	8	6-5/8	3-1/4	4-1/8	5
	90	116S44										
	180	131S44	65	1.2	4.2	33	14	8-7/8	7-1/2	3-1/2	4-1/8	N/A
1-1/4	25	17S15	25	0.4	1.6	18						
	50	117S25	40	0.6	2.4	28	12	8-3/8	6-3/4	3-1/2	4-1/2	7
	140	132S45	65	1.2	4.8	33	16	9-3/8	7-3/4	3-5/8	4-1/2	
	180	† 140S45	85	2.0	9.2	N/A	20	10-3/8	8-3/4	4-1/2	4-1/2	N/A
1-1/2	25	35S16	45	0.8	3.2	23						
	50	35S26					20	10	8-1/8	4	4-7/8	7-3/4
	90	135S46	65	1.2	4.8	33						
	180	141S46	85	2.0	10.0	45	24	11	9-1/8	4-1/2	4-7/8	N/A
2	25	36S17	45	0.8	3.5	23	31	11	8-3/4	5-3/8	6	8
	50	36S27										
	115	42S47	60	1.2	7.4	35	36	12	9-3/4	5-3/8	6	N/A
	180	142S47	85	2.0	11.0	45						
2-1/2	25	43S18										
	50	43S28	60	1.2	8.0	35	43	12-7/8	10-1/8	5-7/8	7-1/4	11
	115	43S48										
	175	143S48	85	2.0	12.0	45						N/A
3	25	44S19										
	50	44S29	60	1.2	8.8	35	56	13-3/4	10-1/2	6-5/8	8-3/8	9-1/2
	100	44S49										
	150	144S49	85	2.0	13.0	45						

† Not available for DC operation ♦ Shipping weights and Dimension "A" apply to NPT Ends

- When ordering please supply:**
- Pipe Size
 - Valve Type
 - Voltage (AC or DC)
 - Hertz
 - Fluid
 - Fluid Temperature
 - Max. Diff. Pressure
 - Optional Features (See pages 26 & 27)

BRONZE Solenoid Valves



MAX. FLUID TEMP. 400° F
MAX. STATIC PRESSURE 200 PSI

TYPE SR FULL PORT NORMALLY OPEN - 1/2" to 3" PIPE SIZE
(NO DIFFERENTIAL PRESSURE REQUIRED TO OPEN)

OPERATION:

Valve closes when energized and opens when de-energized. When the coil is energized the plunger presses the poppet, closing the pilot orifice, and opens a bleed passageway to permit pressure to build above the piston and seat it. Upon de-energizing the coil, the pilot orifice is opened, relieving the pressure above the piston allowing it to leave its seat. The bottom spring allows the valve to operate at zero pressure drop.

CONSTRUCTION: *Wetted parts

- Valve Body* – Cast Bronze, Globe Pattern – NPT ends (Flanged Ends available)
- Piston* – Bronze
- Coil Enclosure – Malleable or Cast Iron, 1/2" NPS conduit conn.
- Plunger* – 430 Stainless Steel
- Poppet* – 303 Stainless Steel
- Stem* – 303 Stainless Steel
- Bonnet Tube* – 304 Stainless Steel
- Springs* – Inconel and 302 Stainless Steel
- Body Seal* – Non Asbestos Gasket (Teflon® available)
- Orifice Seal* – Glass Filled Teflon®
- AC Shading Coil* – Copper
- Stem Pin* – 304 Stainless Steel
- Coil - Encapsulated Class H, 18" leads

APPLICATION:

To control the flow of **Steam**. Steam must be free of sediment. Valve operates from zero to maximum differential pressure indicated in table. Valve must be mounted in horizontal pipe with solenoid enclosure vertical and on top.

Pipe Size Inches	Max. Diff. PSI	Type No.	Watts AC	Amps Hold 120-60	Amps Inrush 120-60	Watts DC	Ship Wt. Lbs.*	Dimensions in Inches					
								A*	B	C	D	D (Flanged) 150#	
1/2	90	14SR22	25	0.5	1.5	18	8	8-1/8	7	2-7/8	3-1/4	4-3/4	
	140	114SR42	40	0.8	2.4	28		9-1/8	8	3-1/2	3-1/4	N/A	
	180	129SR42	65	1.5	4.2	33		11	9-1/8	8	3-1/2	3-1/4	N/A
3/4	50	14SR23	25	0.5	1.6	18	9	7-1/8	6	2-7/8	3-1/2	5-1/2	
	110	114SR43	40	0.8	2.6	28		9-1/4	8-1/8	3-1/2	3-1/2	N/A	
	180	129SR43	65	1.5	4.3	33		13	9-1/4	8-1/8	3-1/2	3-1/2	N/A
1	25	16SR14	25	0.5	1.8	18	11	9-1/8	7-3/4	3-1/4	4-1/8	5	
	50	116SR24	40	0.8	2.9	28		10	8-5/8	3-1/2	4-1/8	N/A	
	90	116SR44	65	1.5	4.5	33		15	10	8-5/8	3-1/2	4-1/8	N/A
1-1/4	25	17SR15	25	0.5	1.9	18	13	9-3/4	8-1/8	3-1/2	4-1/2	7	
	50	117SR25	40	0.8	3.0	28		10-3/4	9-1/8	3-5/8	4-1/2		
	140	132SR45	65	1.5	4.8	33		17	10-3/4	9-1/8	3-5/8		4-1/2
	180	† 140SR45	85	3.5	9.0	N/A		20	11	9-3/8	4-1/2		4-1/2
1-1/2	25	35SR16	45	1.0	3.8	23	21	11-3/8	9-1/2	4	4-7/8	7-3/4	
	50	35SR26	65	1.5	5.7	33		11-5/8	9-3/4	4-1/2	4-7/8	N/A	
	90	135SR46	85	3.5	9.7	45		12-3/8	10-1/8	5-3/8	6	8	
	180	141SR46	85	3.5	11.0	45		36	12-5/8	10-3/8	5-3/8	6	N/A
2	25	36SR17	45	1.0	4.2	23	31	13-1/2	10-3/4	5-7/8	7-1/4	11	
	50	36SR27	60	1.7	7.3	35		45	13-1/2	10-3/4	5-7/8	7-1/4	11
	115	43SR48	85	3.5	12.0	45		57	14-3/8	11-1/8	6-5/8	8-3/8	9-1/2
2-1/2	180	142SR47	85	3.5	11.0	45	45	13-1/2	10-3/4	5-7/8	7-1/4	N/A	
	25	43SR18	60	1.7	8.0	35		13-1/2	10-3/4	5-7/8	7-1/4	11	
	50	43SR28	85	3.5	12.0	45		13-1/2	10-3/4	5-7/8	7-1/4	11	
	115	43SR48	85	3.5	12.0	45		13-1/2	10-3/4	5-7/8	7-1/4	11	
3	25	44SR19	60	1.7	8.8	35	57	14-3/8	11-1/8	6-5/8	8-3/8	9-1/2	
	50	44SR29	85	3.5	13.0	45		14-3/8	11-1/8	6-5/8	8-3/8	9-1/2	
	100	44SR49	85	3.5	13.0	45		14-3/8	11-1/8	6-5/8	8-3/8	9-1/2	
	150	144SR49	85	3.5	13.0	45		14-3/8	11-1/8	6-5/8	8-3/8	9-1/2	

† Not available for DC operation * Shipping weights and Dimension "A" apply to NPT Ends



For Options and Accessories see pages 26 & 27. Strainers are recommended for use with solenoid valves (see page 19).

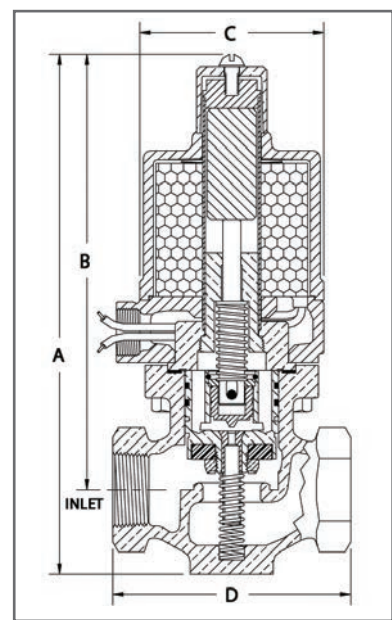

When ordering please supply:

- Pipe Size
- Valve Type
- Voltage (AC or DC)
- Hertz
- Fluid
- Fluid Temperature
- Max. Diff. Pressure
- Optional Features (See pages 26 & 27)

BULLETIN 3020-L

BRONZE Solenoid Valves

MAX. FLUID TEMP. 400° F
 MAX. STATIC PRESSURE 300 PSI
 (Except valves listed for 500 PSI)



For Options and Accessories see pages 26 & 27. Strainers are recommended for use with solenoid valves (see page 19).

TYPE L FULL PORT NORMALLY CLOSED - 1/2" to 3" PIPE SIZE (NO DIFFERENTIAL PRESSURE REQUIRED TO OPEN)

OPERATION: Valve opens when energized and closes when de-energized. When the coil is energized the pilot valve opens, relieving the pressure above the piston, which is then lifted from its seat by the plunger. Upon de-energizing the coil, a spring closes the pilot valve and opens a bleed passageway to permit pressure to build above the piston and seat it.

CONSTRUCTION: *Wetted parts

- Valve Body* – Cast Bronze, Globe Pattern – NPT ends (Flanged Ends available)
- Piston* – Bronze
- Coil Enclosure – Malleable or Cast Iron, 1/2" NPS conduit conn.
- Plunger* – 430 Stainless Steel
- Pilot Valve* – 303 Stainless Steel
- Bonnet Tube* – 304 Stainless Steel
- Spring* – Inconel
- Body Seal* – Non Asbestos Gasket (Teflon® available)
- Orifice Seal* – Glass Filled Teflon®
- AC Shading Coil* – Copper
- Stem Pin* – Inconel
- Coil – Encapsulated Class H, 18" leads

FOR
 STEAM APPLICATIONS
 SEE BULLETIN 3020-S
 Page 12

APPLICATION: To control the flow of Hot Liquids, Hot Gases, Cryogenics** and any other fluids not reactive with construction materials and free of sediment. Cryogenic fluids include Liquid Oxygen (-297°F), Liquid Argon (-303°F) and Liquid Nitrogen (-320°F). Valve operates from zero to maximum differential pressure indicated in table. Valve must be mounted in horizontal pipe with solenoid enclosure vertical and on top.

**Cleaning – Cryogenic valves are degreased and cleaned to keep them free of moisture.
 - Oxygen valves are also "black light" tested.

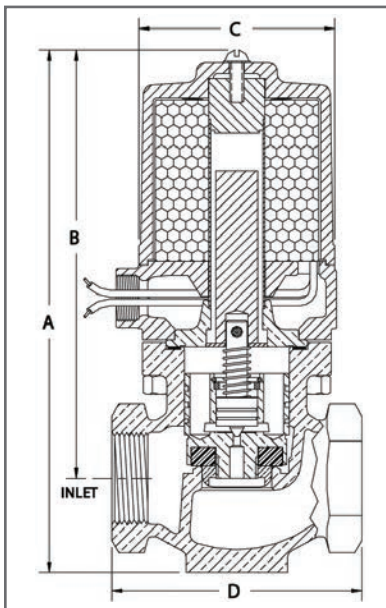

When ordering please supply:

- Pipe Size
- Valve Type
- Voltage (AC or DC)
- Hertz
- Fluid
- Fluid Temperature
- Max. Diff. Pressure
- Optional Features (See pages 26 & 27)

Pipe Size Inches	Max. Diff. PSI	Type No.	Watts AC	Amps Hold 120-60	Amps Inrush 120-60	Watts DC	Ship Wt. Lbs.†	Dimensions in Inches				
								A*	B	C	D	D (Flanged) 150#
1/2	110	14L42	25	0.4	1.2	18	8	7	5-7/8	2-7/8	3-1/4	4-3/4
	200	14L32										
	300	29L52	45	0.8	2.4	23	11	8	6-7/8	3-1/2	3-1/4	N/A
3/4	500	E29L62	45	0.8	2.4	23	16	8	6-7/8	4	3-1/4	N/A
	50	14L23	25	0.4	1.3	18	9	7-1/8	6	2-7/8	3-1/2	5-1/2
	110	14L43										
1	200	29L33	45	0.8	2.6	23	12	8-1/8	7	3-1/2	3-1/2	N/A
	300	129L53	65	1.2	3.9	33	17	8-1/8	7	4	3-1/2	N/A
	500	E129L63	65	1.2	3.9	33	17	8-1/8	7	4	3-1/2	N/A
1-1/4	50	16L24	25	0.4	1.5	18	11	8	6-5/8	3-1/4	4-1/8	5
	110	16L44										
	200	31L34	45	0.8	2.8	23	14	8-7/8	7-1/2	3-1/2	4-1/8	N/A
1-1/2	300	131L54	65	1.2	4.2	33	19	8-7/8	7-1/2	4	4-1/8	N/A
	500	E131L64	65	1.2	4.2	33	19	8-7/8	7-1/2	4	4-1/8	N/A
	50	17L25	25	0.4	1.6	18	12	8-3/8	6-3/4	3-1/2	4-1/2	7
1-1/4	90	17L45										
	200	32L35	45	0.8	3.0	23	16	9-3/8	7-3/4	3-5/8	4-1/2	N/A
	300	132L55	65	1.2	4.5	33	20	10-3/8	8-3/4	4-1/2	4-1/2	N/A
1-1/2	500	† 140L65	85	2.0	9.2	N/A	20	10-3/8	8-3/4	4-1/2	4-1/2	N/A
	50	35L26	45	0.8	3.2	23	20	10	8-1/8	4	4-7/8	7-3/4
	115	35L46										
2	200	41L36	60	1.2	6.7	35	24	11	9-1/8	4-1/2	4-7/8	N/A
	300	141L56	85	2.0	10.0	45	24	11	9-1/8	4-1/2	4-7/8	N/A
	500	141L66	85	2.0	10.0	45	24	11	9-1/8	4-1/2	4-7/8	N/A
2	50	36L27	45	0.8	3.5	23	31	11	8-3/4	5-3/8	6	8
	100	36L47										
	200	42L37	60	1.2	7.4	35	36	12	9-3/4	5-3/8	6	N/A
2-1/2	300	42L57	85	2.0	11.0	45	36	12	9-3/4	5-3/8	6	N/A
	500	142L67	85	2.0	11.0	45	36	12	9-3/4	5-3/8	6	N/A
	50	43L28	60	1.2	8.0	35	43	12-7/8	10-1/8	5-7/8	7-1/4	11
3	125	43L48										
	200	43L38	60	1.2	8.0	35	43	12-7/8	10-1/8	5-7/8	7-1/4	N/A
	300	143L58	85	2.0	12.0	45	43	12-7/8	10-1/8	5-7/8	7-1/4	N/A
3	50	44L29	60	1.2	8.8	35	56	13-3/4	10-1/2	6-5/8	8-3/8	9-1/2
	100	44L49										
	200	44L39	85	2.0	13.0	45	56	13-3/4	10-1/2	6-5/8	8-3/8	N/A
3	300	144L59	85	2.0	13.0	45	56	13-3/4	10-1/2	6-5/8	8-3/8	N/A

† Not available for DC operation † Shipping weights and Dimension "A" apply to NPT Ends

BRONZE Solenoid Valves



MAX. FLUID TEMP. 400° F
MAX. STATIC PRESSURE 300 PSI
 (Except valves listed for 500 PSI)

TYPE LR FULL PORT NORMALLY OPEN - 1/2" to 3" PIPE SIZE
 (NO DIFFERENTIAL PRESSURE REQUIRED TO OPEN)

OPERATION: Valve closes when energized and opens when de-energized. When the coil is energized the plunger presses the poppet, closing the pilot orifice, and opens a bleed passageway to permit pressure to build above the piston and seal it. Upon de-energizing the coil, the pilot orifice is opened, relieving the pressure above the piston allowing it to leave its seat. The bottom spring allows the valve to operate at zero pressure drop.

CONSTRUCTION: *Wetted parts

- Valve Body* – Cast Bronze, Globe Pattern NPT ends (Flanged Ends available)
- Piston* – Bronze
- Coil Enclosure – Malleable or Cast Iron, 1/2" NPS conduit conn.
- Plunger* – 430 Stainless Steel
- Poppet* – 303 Stainless Steel
- Stem* – 303 Stainless Steel
- Bonnet Tube* – 304 Stainless Steel
- Springs* – Inconel and 302 Stainless Steel
- Body Seal* – Non Asbestos Gasket (Teflon® available)
- Orifice Seal* – Glass Filled Teflon®
- AC Shading Coil* – Copper
- Stem Pin* – 304 Stainless Steel
- Coil – Encapsulated Class H, 18" leads

**FOR
STEAM APPLICATIONS
SEE BULLETIN 3020-SR
Page 13**

APPLICATION: To control the flow of Hot Liquids, Hot Gases, Cryogenics** and any other fluids not reactive with construction materials and free of sediment. Cryogenic fluids include Liquid Oxygen (-297°F), Liquid Argon (-303°F) and Liquid Nitrogen (-320°F). Valve operates from zero to maximum differential pressure indicated in table. Valve must be mounted in horizontal pipe with solenoid enclosure vertical and on top.

****Cleaning** – Cryogenic valves are degreased and cleaned to keep them free of moisture.
 – Oxygen valves are also "black light" tested.

Pipe Size Inches	Max. Diff. PSI	Type No.	Watts AC	Amps Hold 120-60	Amps Inrush 120-60	Watts DC	Ship Wt. Lbs.†	Dimensions in Inches				
								A*	B	C	D	D (Flanged) 150#
1/2	110	14LR42	25	0.5	1.5	18	8	8-1/8	7	2-7/8	3-1/4	4-3/4
	200	14LR32										
	300	29LR52	45	1.0	2.7	23	11	9-1/8	8	3-1/2	3-1/4	N/A
	500	E29LR62	45	1.0	2.7	23	16	9-1/8	8	4	3-1/4	N/A
3/4	50	14LR23	25	0.5	1.6	18	9	8-1/4	7-1/8	2-7/8	3-1/2	5-1/2
	110	14LR43										
	200	29LR33	45	1.0	2.9	23	13	9-1/4	8-1/8	3-1/2	3-1/2	N/A
	300	129LR53	65	1.5	4.3	33	18	9-1/4	8-1/8	4	3-1/2	N/A
	500	E129LR63	65	1.5	4.3	33	18	9-1/4	8-1/8	4	3-1/2	N/A
1	50	16LR24	25	0.5	1.8	18	11	9-1/8	7-3/4	3-1/4	4-1/8	5
	110	16LR44										
	200	31LR34	45	1.0	3.0	23	15	10	8-5/8	3-1/2	4-1/8	N/A
	300	131LR54	65	1.5	4.5	33	20	10	8-5/8	4	4-1/8	N/A
	500	E131LR64	65	1.5	4.5	33	20	10	8-5/8	4	4-1/8	N/A
1-1/4	50	17LR25	25	0.5	1.9	18	13	9-3/4	8-1/8	3-1/2	4-1/2	7
	90	17LR45										
	200	32LR35	45	1.0	3.2	23	17	10-3/4	9-1/8	3-5/8	4-1/2	N/A
	300	132LR55	65	1.5	4.8	33	20	11	9-3/8	4-1/2	4-1/2	N/A
	500	† 140LR65	85	3.5	9.0	N/A	20	11	9-3/8	4-1/2	4-1/2	N/A
1-1/2	50	35LR26	45	1.0	3.8	23	21	11-3/8	9-3/8	4	4-7/8	7-3/4
	115	35LR46										
	200	41LR36	60	1.7	6.5	35	25	11-5/8	9-3/4	4-1/2	4-7/8	N/A
	300	141LR56	85	3.5	9.7	45	25	11-5/8	9-3/4	4-1/2	4-7/8	N/A
	500	141LR66	85	3.5	9.7	45	25	11-5/8	9-3/4	4-1/2	4-7/8	N/A
2	50	36LR27	45	1.0	4.2	23	31	12-3/8	10-1/8	5-3/8	6	8
	100	36LR47										
	200	42LR37	60	1.7	7.3	35	36	12-5/8	10-3/8	5-3/8	6	N/A
	300	42LR57	85	3.5	11.0	45	36	12-5/8	10-3/8	5-3/8	6	N/A
2-1/2	50	43LR28	60	1.7	8.0	35	45	13-1/2	10-3/4	5-7/8	7-1/4	11
	125	43LR48										
	200	43LR38	60	1.7	8.0	35	45	13-1/2	10-3/4	5-7/8	7-1/4	N/A
	300	143LR58	85	3.5	12.0	45	45	13-1/2	10-3/4	5-7/8	7-1/4	N/A
3	50	44LR29	60	1.7	8.8	35	57	14-3/8	11-1/8	6-5/8	8-3/8	9-1/2
	100	44LR49										
	200	44LR39	60	1.7	8.8	35	57	14-3/8	11-1/8	6-5/8	8-3/8	N/A
	300	144LR59	85	3.5	13.0	45	57	14-3/8	11-1/8	6-5/8	8-3/8	N/A

† Not available for DC operation † Shipping weights and Dimension "A" apply to NPT Ends



For Options and Accessories see pages 26 & 27. Strainers are recommended for use with solenoid valves (see page 19).

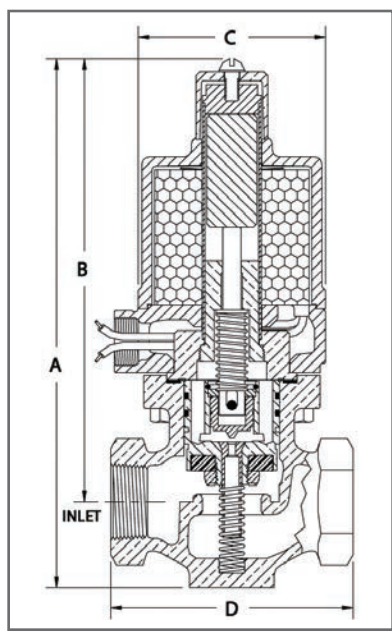

When ordering please supply:

- Pipe Size
- Valve Type
- Voltage (AC or DC)
- Hertz
- Fluid
- Fluid Temperature
- Max. Diff. Pressure
- Optional Features (See pages 26 & 27)

BULLETIN 3020-G

MAX. FLUID TEMP. 212° F
MAX. STATIC PRESSURE 150 PSI



For Options and Accessories see pages 26 & 27. Strainers are recommended for use with solenoid valves (see page 19).

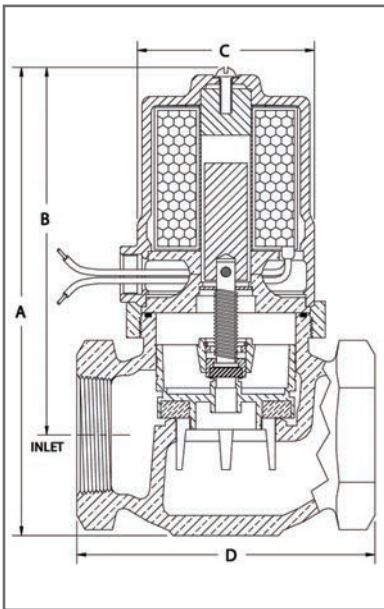

When ordering please supply:

- Pipe Size
- Fluid
- Valve Type
- Fluid Temperature
- Voltage (AC or DC)
- Max. Diff. Pressure
- Optional Features (See pages 26 & 27)
- Hertz

BRONZE Solenoid Valves

TYPE G FULL PORT NORMALLY CLOSED - 1" to 3" PIPE SIZE

(NO DIFFERENTIAL PRESSURE REQUIRED TO OPEN)

OPERATION:

Valve opens when energized and closes when de-energized. When the coil is energized the pilot valve opens, relieving the pressure above the piston, which is then lifted from its seat by the plunger. Upon de-energizing the coil, a spring closes the pilot valve and opens a bleed passageway to permit pressure to build above the piston and seat it.

CONSTRUCTION: * Wetted parts

- Valve Body* – Cast Bronze, Globe Pattern – NPT ends (Flanged Ends available)
- Piston* – Bronze
- Coil Enclosure – Malleable or Cast Iron, 1/2" NPS conduit conn.
- Plunger* – 430 Stainless Steel
- Pilot Valve Stem* – 303 Stainless Steel
- Pilot Valve Disc Holder* – Brass
- Pilot Valve Seal* – Buna N (Viton® available)
- Bonnet Tube* – 304 Stainless Steel
- Spring* – 302 Stainless Steel
- Body Seal* – Buna N or Non Asbestos Gasket (Viton® or Teflon® available)
- Orifice Seal* – Buna N (Viton® or Glass Filled Teflon® available)
- AC Shading Coil* – Copper
- Stem Pin* – Inconel
- Coil – Encapsulated Class B, 18" leads – (Class H available)

APPLICATION:

To control the flow of **Water, Air, Gas, Solvents, Vacuum** and any other fluids not reactive with construction materials and free of sediment. Buna N seating of the pilot and main orifices make the valves ideal for TIGHT SEATING, LOW PRESSURE and LOW FLOW conditions. Valve operates from zero to maximum differential pressure indicated in table. Valve must be mounted in horizontal pipe with solenoid enclosure vertical and on top.

Pipe Size Inches	Max. Diff. PSI	Type No.	Watts AC	Amps Hold 120-60	Amps Inrush 120-60	Watts DC	Ship Wt. Lbs.†	Dimensions in Inches				
								A*	B	C	D	D (Flanged) 150#
1	20	18G24	25	0.4	1.4	18	9	7-1/2	6-1/8	2-3/4	4-1/8	6-3/4
	30	118G24	40	0.6	2.3	28	9	7-1/2	6-1/8	2-3/4	4-1/8	
	50	133G24	65	1.2	4.0	33	13	8-1/2	7-1/8	3-1/2	4-1/8	
1-1/4	20	18G25	25	0.4	1.5	18	10	8	6-3/8	2-7/8	4-3/8	7
	30	118G25	40	0.6	2.4	28	10	8	6-3/8	2-7/8	4-3/8	
	50	133G25	65	1.2	4.1	33	14	8-7/8	7-3/8	3-1/2	4-3/8	
1-1/2	15	18G26	25	0.4	1.7	18	12	8-1/8	6-1/2	3-1/8	4-3/4	7-3/4
	25	118G26	40	0.6	2.5	28	12	8-1/8	6-1/2	3-1/8	4-3/4	
	35	133G26	65	1.2	4.2	33	16	9-1/8	7-1/2	3-1/2	4-3/4	
2	18	33G27	45	0.8	3.4	23	20	9-7/8	7-7/8	3-3/4	5-3/4	10
	30	133G27	65	1.2	4.2	33	20	9-7/8	7-7/8	3-3/4	5-3/4	
	50	233G27	80	1.8	9.0	40	20	9-7/8	7-7/8	3-3/4	5-3/4	
2-1/2	25	43G28	60	1.2	7.8	35	38	12-1/8	9-5/8	5-7/8	7-1/8	11
	35	143G28	85	2.0	12.0	45	38	12-1/8	9-5/8	5-7/8	7-1/8	
3	25	44G29	60	1.2	8.6	35	46	13	10	6-5/8	8	13-5/16
	35	144G29	85	2.0	13.0	45	46	13	10	6-5/8	8	

† Shipping weights and Dimension "A" apply to NPT Ends

BRONZE Solenoid Valves



MAX. FLUID TEMP. 212° F
MAX. STATIC PRESSURE 150 PSI

TYPE GR FULL PORT NORMALLY OPEN - 1" to 3" PIPE SIZE
(NO DIFFERENTIAL PRESSURE REQUIRED TO OPEN)

OPERATION:

Valve closes when energized and opens when de-energized. When the coil is energized the plunger presses the poppet, closing the pilot orifice, and opens a bleed passageway to permit pressure to build above the piston and seat it. Upon de-energizing the coil, the pilot orifice is opened, relieving the pressure above the piston allowing it to leave its seat. The bottom spring allows the valve to operate at zero pressure drop.

CONSTRUCTION: * Wetted parts

- Valve Body* – Cast Bronze, Globe Pattern – NPT ends (Flanged Ends available)
- Piston* – Bronze
- Coil Enclosure – Malleable or Cast Iron, 1/2" NPS conduit conn.
- Plunger* – 430 Stainless Steel
- Pilot Valve Stem* – 303 Stainless Steel
- Pilot Valve Disc Holder* – Brass
- Pilot Valve Seal* – Buna N (Viton® available)
- Bonnet Tube* – 304 Stainless Steel
- Spring* – 302 Stainless Steel
- Body Seal* – Buna N or Non Asbestos Gasket (Viton® or Teflon® available)
- Orifice Seal* – Buna N (Viton® or Glass Filled Teflon® available)
- AC Shading Coil* – Copper
- Stem Pin* – Inconel
- Coil – Encapsulated Class B, 18" leads – (Class H available)

APPLICATION:

To control the flow of **Water, Air, Gas, Solvents, Vacuum** and any other fluids not reactive with construction materials and free of sediment. Buna N seating of the pilot and main orifices make the valves ideal for TIGHT SEATING, LOW PRESSURE and LOW FLOW conditions. Valve operates from zero to maximum differential pressure indicated in table. Valve must be mounted in horizontal pipe with solenoid enclosure vertical and on top.

Pipe Size Inches	Max. Diff. PSI	Type No.	Watts AC	Amps Hold 120-60	Amps Inrush 120-60	Watts DC	Ship Wt. Lbs.*	Dimensions in Inches				
								A*	B	C	D	D (Flanged) 150#
1	20	18GR24	25	0.5	1.5	18	9	8-5/8	7-1/4	2-3/4	4-1/8	6-3/4
	35	33GR24	45	1.0	3.0	23	13	9-5/8	8-1/4	2-3/4	4-1/8	
1-1/4	20	18GR25	25	0.5	1.9	18	10	9-3/8	7-3/4	2-7/8	4-3/8	7
	35	33GR25	45	1.0	3.2	23	14	10-1/4	8-3/4	3-1/2	4-3/8	
1-1/2	15	18GR26	25	0.5	2.0	18	12	9-1/2	7-7/8	3-1/8	4-3/4	7-3/4
	25	33GR26	45	1.0	3.8	23	16	10-1/2	8-7/8	3-1/2	4-3/4	
2	18	33GR27	45	1.0	4.2	23	21	11-1/4	9-1/4	3-3/4	5-3/4	10
	30	133GR27	65	1.5	4.5	33	21	11-1/4	9-1/4	3-3/4	5-3/4	
2-1/2	25	43GR28	60	1.7	8.0	35	39	12-3/4	10-1/4	5-7/8	7-7/8	11
3	25	44GR29	60	1.7	8.8	35	47	13-5/8	10-5/8	6-5/8	8	13-5/16

* Shipping weights and Dimension "A" apply to NPT Ends



For Options and Accessories see pages 26 & 27. Strainers are recommended for use with solenoid valves (see page 19).

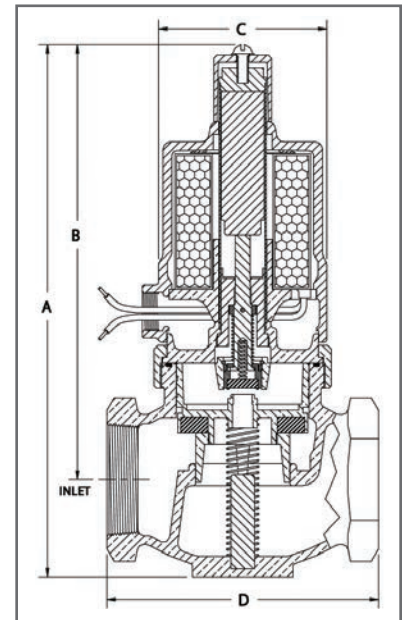

When ordering please supply:

- Pipe Size
- Valve Type
- Voltage (AC or DC)
- Hertz
- Fluid
- Fluid Temperature
- Max. Diff. Pressure
- Optional Features (See pages 26 & 27)

BULLETIN 3020-D

BRONZE Solenoid Valves

TYPE D FULL PORT NORMALLY CLOSED - 3/8" to 2" PIPE SIZE (NO DIFFERENTIAL PRESSURE REQUIRED TO OPEN)

MAX. FLUID TEMP. 212° F
MAX. STATIC PRESSURE 150 PSI

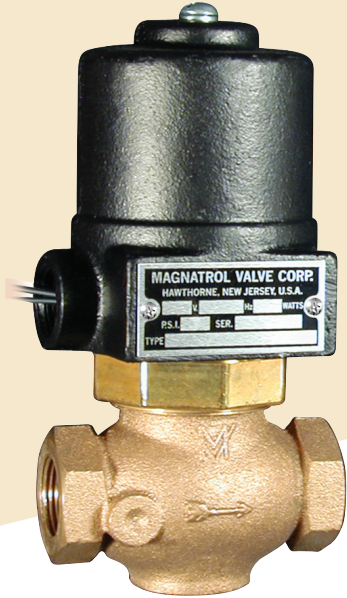

OPERATION:

Valve opens when energized and closes when de-energized. In this direct acting valve the disc holder assembly is lifted from its seat by the plunger.

CONSTRUCTION: * Wetted parts

- Valve Body* – Cast Bronze, Globe Pattern – NPT ends (**Flanged Ends available**)
- Disc Holder* – Brass
- Coil Enclosure – Malleable or Cast Iron, 1/2" NPS conduit conn.
- Plunger* – 430 Stainless Steel
- Stem* – 303 Stainless Steel
- Bonnet Tube* – 304 Stainless Steel
- Spring* – 302 Stainless Steel
- Body Seal* – Buna N (**Viton® available**)
- Orifice Seal* – Buna N (**Viton® or Glass Filled Teflon® available**)
- AC Shading Coil* – Copper
- Stem Pin* – Inconel
- Coil – Encapsulated Class B, 18" leads – (**Class H available**)

APPLICATION:

To control the flow of **Water, Air, Gas, Solvents, Vacuum** and any other fluids not reactive with construction materials and free of sediment. Buna N seating of the orifice make the valves ideal for TIGHT SEATING, LOW PRESSURE and LOW FLOW conditions. Valve operates from zero to maximum differential pressure indicated in table. Valve must be mounted in horizontal pipe with solenoid enclosure vertical and on top.

For Options and Accessories see pages 26 & 27. Strainers are recommended for use with solenoid valves (see page 19).

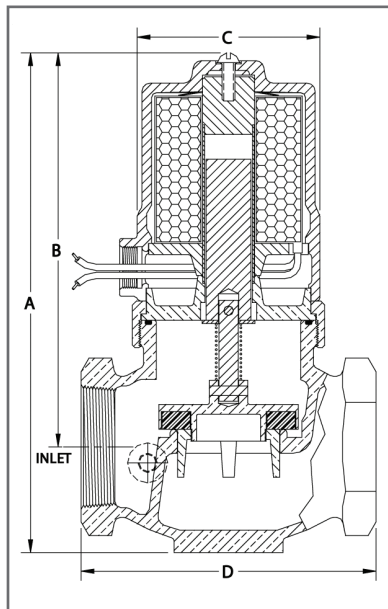

Pipe Size Inches	Max. Diff. PSI	Type No.	Watts AC	Amps Hold 120-60	Amps Inrush 120-60	Watts DC	Ship Wt. Lbs.*	Dimensions in Inches				
								A*	B	C	D	D (Flanged) 150#
3/8	15	18D11	25	0.4	1.0	18	7	6-1/4	5-3/8	2-3/4	2-7/8	N/A
	30	33D11	45	0.8	2.3	23	10	7-1/8	6-3/8	3-1/2	2-7/8	
1/2	10	18D12	25	0.4	1.1	18	7	6-1/4	5-1/2	2-3/4	3-1/8	4-3/4
	20	33D12	45	0.8	2.4	23	10	7-1/4	6-3/8	3-1/2	3-1/8	
3/4	4	18D13	25	0.4	1.2	18	8	6-7/8	5-3/4	2-3/4	3-1/2	5-1/2
	7.5	33D13	45	0.8	2.5	23	12	7-3/4	6-3/4	3-1/2	3-1/2	
1	2	18D14	25	0.4	1.4	18	9	7-1/2	6-1/8	2-3/4	4-1/8	6-3/4
	3.5	33D14	45	0.8	2.7	23	13	8-1/2	7-1/8	3-1/2	4-1/8	
1-1/4	1.3	18D15	25	0.4	1.5	18	10	8	6-3/8	2-7/8	4-3/8	7
	2.3	33D15	45	0.8	2.8	23	14	8-7/8	7-3/8	3-1/2	4-3/8	
1-1/2	0.8	18D16	25	0.4	1.7	18	12	8-1/8	6-1/2	3-1/8	4-3/4	7-3/4
	1.5	33D16	45	0.8	3.0	23	15	9-1/8	7-1/2	3-1/2	4-3/4	
2	0.8	33D17	45	0.8	3.4	23	19	9-7/8	7-7/8	3-3/4	5-3/4	10
	1.2	133D17	65	1.2	4.2	33	19	9-7/8	7-7/8	3-3/4	5-3/4	

* Shipping weights and Dimension "A" apply to NPT Ends

When ordering please supply:

- Pipe Size
- Fluid
- Valve Type
- Fluid Temperature
- Voltage (AC or DC)
- Max. Diff. Pressure
- Hertz
- Optional Features (See pages 26 & 27)

STRAINERS

BRONZE • STAINLESS STEEL

APPLICATION:

The presence of foreign particles in an automatic valve may seriously affect its dependability. The installation of a strainer close to the inlet side of the valve is the best means of preventing the entrance of pipe chips, scale, rust, pipe dope, welding slag or sediment into the valve, provided the screen is periodically removed for cleaning.

CONSTRUCTION:

Strainer bodies have screwed ends. Screens are stainless steel with opening sizes as listed in tables below. Other sizes can be furnished upon request. Liberal straining area provides for fluid passage at minimum pressure drop. Screens are easily removed for cleaning. Strainers are furnished with NPT blow-off connections unplugged. See charts below for blow-off sizes (C Dim.)

CLEANING FOR CRYOGENIC AND OXYGEN SERVICE:

Strainers for Cryogenic applications are degreased and cleaned to keep them free of moisture. Strainers for Oxygen service are degreased and cleaned, then "black light" tested.



BRONZE 1/4" to 3" PIPE SIZE

Pipe Size Inches	Screen Size	Type No.	Ship Wt. Lbs.	Dimensions in Inches			
				A	B	C	
1/4	60 Mesh 0.009 Openings	BR0	3/4	2-3/4	2-1/4	1/4	
3/8		BR1	3/4	2-3/4	2-1/4	1/4	
1/2		BR2	3/4	2-3/4	2-1/4	1/4	
3/4		BR3	1-1/2	3	2-9/16	3/8	
1		BR4	2-1/4	3-3/4	2-3/4	3/8	
1-1/4		0.16 Diameter Perforations Lined With 30 Mesh	BR5	3-1/4	4-7/16	3-5/8	3/4
1-1/2			BR6	4-1/2	4-15/16	3-7/8	3/4
2			BR7	7	6-1/8	5-1/16	1
2-1/2			BR8	12-1/2	8-1/4	6	1-1/4
3	BR9		18	9	6-3/4	1-1/2	

STAINLESS STEEL 1/2" to 2" PIPE SIZE

Pipe Size Inches	Screen Size	Type No.	Ship Wt. Lbs.	Dimensions in Inches		
				A	B	C
1/2	60 Mesh 0.009 Openings	SS2	1-1/2	3	2-3/8	1/4
3/4		SS3	2-1/4	3-3/4	2-13/16	3/8
1		SS4	3-1/4	4-5/8	3-1/8	3/8
1-1/2	0.16 Diameter Perforations Lined With 30 Mesh	SS6	6-3/4	5-5/8	4-3/4	3/4
2		SS7	11-1/2	7	6	1

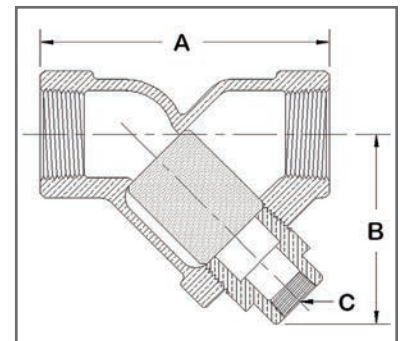

PRESSURE TEMPERATURE RATINGS

Material	Steam	Liquids
BRONZE	300 PSI @ 350°F	400 PSI @ -20 to 150°F
STAINLESS STEEL	845 PSI @ 750°F	1,440 PSI @ 100°F

BULLETIN 3020-J

STAINLESS STEEL Solenoid Valves

MAX. FLUID TEMP. 400° F
MAX. STATIC PRESSURE 300 PSI

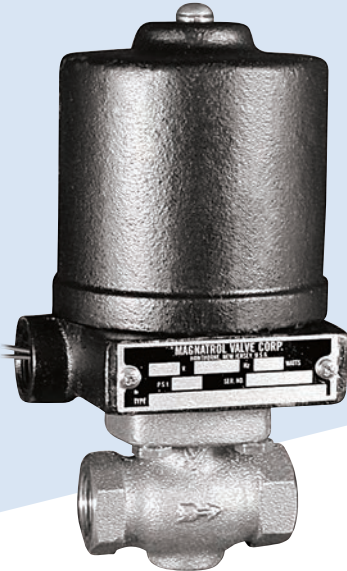

TYPE J **NORMALLY CLOSED - 3/8" to 1/2" PIPE SIZE**
(NO DIFFERENTIAL PRESSURE REQUIRED TO OPEN)

OPERATION:

Valve opens when energized and closes when de-energized. In this direct acting valve, when the coil is energized, the stem is lifted from its conical seat by the plunger.
Direct Acting Orifice Sizes – 1/8" to 3/8"

CONSTRUCTION: *Wetted parts

- Valve Body* – 304 Stainless Steel Globe Pattern – NPT ends
- Coil Enclosure – Malleable Iron, 1/2" NPS conduit conn.
- Plunger* – 430 Stainless Steel
- Valve Stem* – 303 Stainless Steel
- Bonnet Tube* – 304 Stainless Steel
- Spring* – Inconel
- Body Seal* – Non Asbestos Gasket (Teflon® available)
- Orifice Seal* – Metal to Metal (Viton® available)
- AC Shading Coil* – Silver
- Stem Pin* – Inconel
- Coil – Encapsulated Class H, 18" leads

APPLICATION:

To control the flow of **Steam, Hot Liquids, Hot Gases, Cryogenics**** and any other fluids not reactive with construction materials and free of sidentment. Cryogenic fluids include Liquid Oxygen (-297°F), Liquid Argon (-303°F) and Liquid Nitrogen (-320°F). Valve operates from zero to maximum differential pressure indicated in table. Valve must be mounted in horizontal pipe with solenoid enclosure vertical and on top.

****Cleaning** – Cryogenic valves are degreased and cleaned to keep them free of moisture.
– Oxygen valves are also "black light" tested.

For Options and Accessories see pages 26 & 27. Strainers are recommended for use with solenoid valves (see page 19).

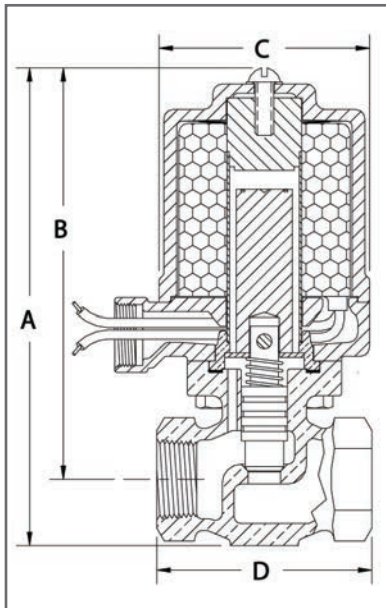

Pipe Size Inches	Max. Diff. PSI	Valve Port Size	Type No.	Watts AC	Amps Hold 120-60	Amps Inrush 120-60	Watts DC	Ship Wt. Lbs.	Dimensions in Inches			
									A	B	C	D
3/8	25	3/8	10J21	25	0.4	1.1	18	6	6-1/4	5-1/2	2-7/8	2-3/4
	75	3/16	10J51									
	150	1/8	10J61									
	50	3/8	25J21	45	0.8	2.3	23	10	7-1/8	6-3/8	3-1/2	2-3/4
	150	3/16	25J51									
300	1/8	25J61										
1/2	25	3/8	10J22	25	0.4	1.2	18	6	6-1/4	5-1/2	2-7/8	2-3/4
	75	3/16	10J52									
	150	1/8	10J62									
	50	3/8	25J22	45	0.8	2.4	23	10	7-1/8	6-3/8	3-1/2	2-3/4
	150	3/16	25J52									
	300	1/8	25J62									

Optional Viton® "Soft Seat" Orifice Seal

- For applications requiring tight seating
- Suitable for Fuel Oils, Gaseous Oxygen and other compatible fluids

When ordering please supply:

- Pipe Size
- Fluid
- Valve Type
- Fluid Temperature
- Voltage (AC or DC)
- Max. Diff. Pressure
- Hertz
- Optional Features (See pages 26 & 27)

STAINLESS STEEL Solenoid Valves



TYPE JR **NORMALLY OPEN - 3/8" to 1/2" PIPE SIZE**
(NO DIFFERENTIAL PRESSURE REQUIRED TO OPEN)

MAX. FLUID TEMP. 400° F
MAX. STATIC PRESSURE 300 PSI

OPERATION:

Valve closes when energized and opens when de-energized. In this direct acting valve, when the coil is energized, the stem is pressed into its conical seat by the plunger.

Direct Acting Orifice Sizes – 1/8" to 3/8"

CONSTRUCTION: * Wetted parts

- Valve Body* – 304 Stainless Steel Globe Pattern – NPT ends
- Coil Enclosure – Malleable Iron, 1/2" NPS conduit conn.
- Plunger* – 430 Stainless Steel
- Poppet* – 304 Stainless Steel
- Stem* – 303 Stainless Steel
- Bonnet Tube* – 304 Stainless Steel
- Spring* – Inconel
- Body Seal* – Non Asbestos Gasket (Teflon® available)
- Orifice Seal* – Metal to Metal (Viton® available)
- AC Shading Coil* – Silver
- Stem Pin* – Inconel
- Coil – Encapsulated Class H, 18" leads

APPLICATION:

To control the flow of **Steam, Hot Liquids, Hot Gases, Cryogenics**** and any other fluids not reactive with construction materials and free of sidement. Cryogenic fluids include Liquid Oxygen (-297°F), Liquid Argon (-303°F) and Liquid Nitrogen (-320°F). Valve operates from zero to maximum differential pressure indicated in table. Valve must be mounted in horizontal pipe with solenoid enclosure vertical and on top.

- **Cleaning** – Cryogenic valves are degreased and cleaned to keep them free of moisture.
– Oxygen valves are also "black light" tested.

Pipe Size Inches	Max. Diff. PSI	Valve Port Size	Type No.	Watts AC	Amps Hold 120-60	Amps Inrush 120-60	Watts DC	Ship Wt. Lbs.	Dimensions in Inches			
									A	B	C	D
3/8	23	3/8	10JR21	25	0.5	1.4	18	7	7	6-1/4	2-7/8	2-3/4
	70	3/16	10JR51									
	135	1/8	10JR61									
	45	3/8	25JR21	45	1.0	2.6	23	10	7-7/8	7-1/8	3-1/2	2-3/4
	135	3/16	25JR51									
300	1/8	25JR61										
1/2	23	3/8	10JR22	25	0.5	1.5	18	7	7	6-1/4	2-7/8	2-3/4
	70	3/16	10JR52									
	135	1/8	10JR62									
	45	3/8	25JR22	45	1.0	2.7	23	10	7-7/8	7-1/8	3-1/2	2-3/4
	135	3/16	25JR52									
300	1/8	25JR62										

- Optional Viton® "Soft Seat" Orifice Seal**
- For applications requiring tight seating
 - Suitable for Fuel Oils, Gaseous Oxygen and other compatible fluids

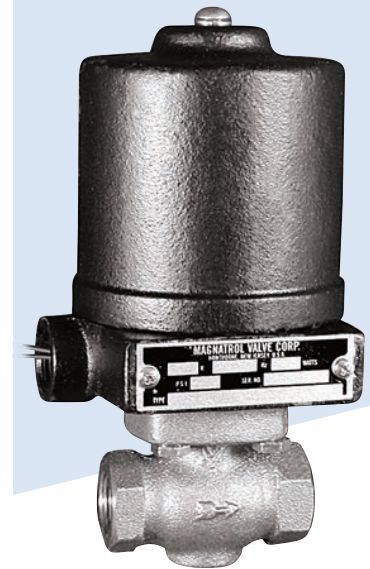

For Options and Accessories see pages 26 & 27. Strainers are recommended for use with solenoid valves (see page 19).

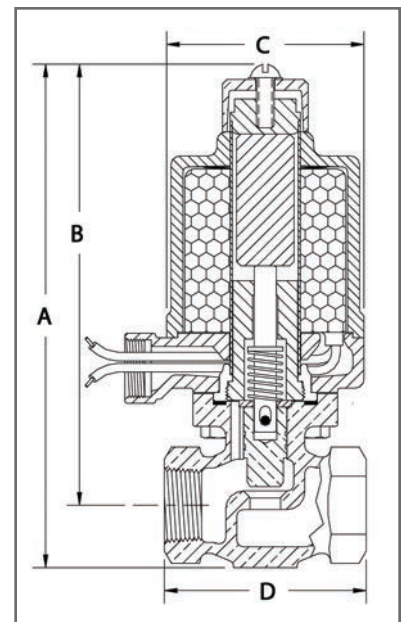

- When ordering please supply:**
- Pipe Size
 - Valve Type
 - Voltage (AC or DC)
 - Hertz
 - Fluid
 - Fluid Temperature
 - Max. Diff. Pressure
 - Optional Features (See pages 26 & 27)

BULLETIN 3020-K

MAX. FLUID TEMP. 400° F
 MAX. STATIC PRESSURE 300 PSI
 (Except valves listed for 500 PSI)

STAINLESS STEEL Solenoid Valves

TYPE K FULL PORT NORMALLY CLOSED - 1/2" to 3" PIPE SIZE
 (NO DIFFERENTIAL PRESSURE REQUIRED TO OPEN)

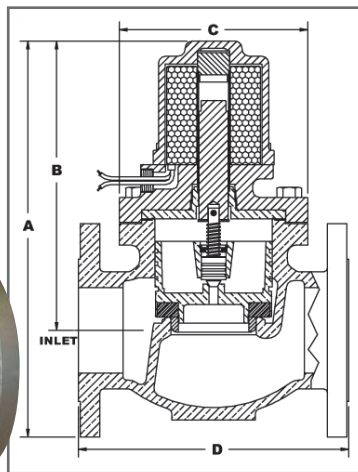
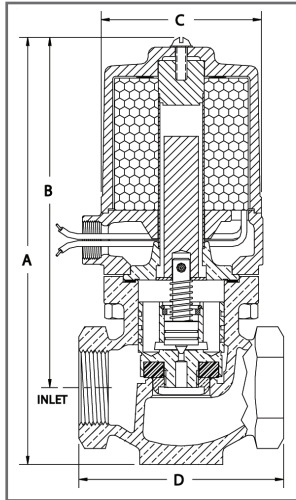

OPERATION: Valve opens when energized and closes when de-energized. When the coil is energized the pilot valve opens, relieving the pressure above the piston, which is then lifted from its seat by the plunger. Upon de-energizing the coil, a spring closes the pilot valve and opens a bleed passageway to permit pressure to build above the piston and seat it.

CONSTRUCTION: *Wetted parts - No Copper Bearing Alloys in contact with fluid

- Valve Body* - 304 Stainless Steel Globe Pattern - AC Shading Coil* - Silver
- NPT ends (Flanged Ends available)
- Piston* - 303 Stainless Steel - Stem Pin* - Inconel
- Coil Enclosure - Malleable or Cast Iron, 1/2" NPS conduit conn. - Coil - Encapsulated Class H, 18" leads
- Plunger* - 430 Stainless Steel
- Pilot Valve* - 303 Stainless Steel
- Bonnet Tube* - 304 Stainless Steel
- Spring* - Inconel
- Body Seal* - Non Asbestos Gasket (Teflon® available)
- Orifice Seal* - Glass Filled Teflon®

**FOR
 STEAM APPLICATIONS
 SEE BULLETIN 3020-W
 Page 24**

APPLICATION: To control the flow of Corrosive Fluids, Deionized Water, Condensate, Ammonias, Vegetable Oils, Fuel Oils, Cryogenics**, and Flammable Liquids. Cryogenic fluids include Liquid Oxygen (-297°F), Liquid Argon (-303°F) and Liquid Nitrogen (-320°F). Valve operates from zero to maximum differential pressure indicated in table. Valve must be mounted in horizontal pipe with solenoid enclosure vertical and on top.

- **Cleaning** - Cryogenic valves are degreased and cleaned to keep them free of moisture.
 - Oxygen valves are also "black light" tested.



For Options and Accessories see pages 26 & 27. Strainers are recommended for use with solenoid valves (see page 19).

When ordering please supply:

- Pipe Size
- Fluid
- Valve Type
- Fluid Temperature
- Voltage (AC or DC)
- Max. Diff. Pressure
- Hertz
- Optional Features (See pages 26 & 27)

Shipping Weights shown here apply to Threaded Ends Only (except 3" which are Flanged Only)

For Flanged Ends contact factory for complete weight and dimensions

3" STAINLESS STEEL VALVES are SUPPLIED with FLANGED ENDS ONLY

Pipe Size Inches	Max. Diff. PSI	Type No.	Watts AC	Amps Hold 120-60	Amps Inrush 120-60	Watts DC	Ship Wt. Lbs.†	Dimensions in Inches					
								A*	B	C	D NPT	D (Flanged) 150# 300#	
1/2	110	14K42	25	0.4	1.2	18	7	7	5-7/8	2-7/8	3-1/4	6	
	200	14K32											
	300	29K52	45	0.8	2.4	23	10	8	6-7/8	3-1/2		6-1/2	
	500	E29K62											
3/4	110	14K43	25	0.4	1.3	18	8	7-1/8	6	2-7/8	3-1/2	6	
	200	29K33											
	300	129K53	65	1.2	3.9	33	11	8-1/8	7	3-1/2	3-1/2	6-1/2	
	500	E129K63											
1	110	16K44	25	0.4	1.5	18	10	8	6-5/8	3-1/4	4-1/8	5	
	200	31K34											
	300	131K54	65	1.2	4.2	33	13	8-7/8	7-1/2	3-1/2	4-1/8	6-1/2	
	500	E131K64											
1-1/2	115	35K46	45	0.8	3.2	23	17	10	8-1/8	4	4-7/8	6-1/2	
	200	41K36											
	300	141K56	85	2.0	10.0	45	21	11	9-1/8	4-1/2	4-7/8	7-1/2	
	500	141K66											
2	100	36K47	45	0.8	3.5	23	27	11	8-3/4	5-3/8	6	8	
	200	42K37											
	300	42K57	60	1.2	7.4	35	32	12	9-3/4	5-3/8	6	9	
	500	142K67											
3	100	44K49F1	60	1.2	8.8	35	68	13-3/4	10-1/2	6-5/8	N/A	9-1/2	N/A
	200	44K39F1											
	300	144K59F3	85	2.0	13.0	45	81				N/A	12-1/2	

† Shipping weights and Dimension "A" apply to NPT Ends

STAINLESS STEEL Solenoid Valves



MAX. FLUID TEMP. 400° F
MAX. STATIC PRESSURE 300 PSI
 (Except valves listed for 500 PSI)



For Options and Accessories see pages 26 & 27. Strainers are recommended for use with solenoid valves (see page 19).

When ordering please supply:

- Pipe Size
- Valve Type
- Voltage (AC or DC)
- Hertz
- Fluid
- Fluid Temperature
- Max. Diff. Pressure
- Optional Features (See pages 26 & 27)

Shipping Weights shown here apply to Threaded Ends Only (except 3" which are Flanged Only)

For Flanged Ends contact factory for complete weight and dimensions
3" STAINLESS STEEL VALVES are SUPPLIED with FLANGED ENDS ONLY

TYPE KR FULL PORT NORMALLY OPEN - 1/2" to 3" PIPE SIZE
 (NO DIFFERENTIAL PRESSURE REQUIRED TO OPEN)

OPERATION: Valve closes when energized and opens when de-energized. When the coil is energized the plunger presses the poppet, closing the pilot orifice, and opens a bleed passageway to permit pressure to build above the piston and seat it. Upon de-energizing the coil, the pilot orifice is opened, relieving the pressure above the piston allowing it to leave its seat. The bottom spring allows the valve to operate at zero pressure drop.

- CONSTRUCTION:** *Wetted parts - No Copper Bearing Alloys in contact with fluid
- Valve Body* – 304 Stainless Steel Globe Pattern NPT ends (Flanged Ends available)
 - Piston* – 303 Stainless Steel
 - Coil Enclosure – Malleable or Cast Iron, 1/2" NPS conduit conn.
 - Plunger* – 430 Stainless Steel
 - Poppet* – 303 Stainless Steel
 - Stem* – 303 Stainless Steel
 - Bonnet Tube* – 304 Stainless Steel
 - Spring* – Inconel
 - Body Seal* – Non Asbestos Gasket (Teflon® available)
 - Orifice Seal* – Glass Filled Teflon®
 - AC Shading Coil* – Silver
 - Stem Pin* – 304 Stainless Steel
 - Coil – Encapsulated Class H, 18" leads

FOR STEAM APPLICATIONS SEE BULLETIN 3020-WR Page 25

APPLICATION: To control the flow of Corrosive Fluids, Deionized Water, Condensate, Ammonias, Vegetable Oils, Fuel Oils, Cryogenics**, and Flammable Liquids. Cryogenic fluids include Liquid Oxygen (-297°F), Liquid Argon (-303°F) and Liquid Nitrogen (-320°F). Valve operates from zero to maximum differential pressure indicated in table. Valve must be mounted in horizontal pipe with solenoid enclosure vertical and on top.

****Cleaning** – Cryogenic valves are degreased and cleaned to keep them free of moisture.
 - Oxygen valves are also "black light" tested.

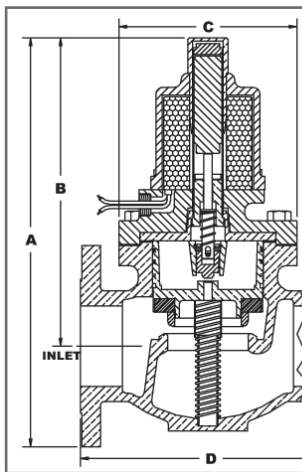
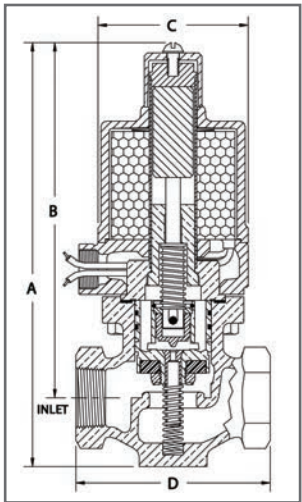

Pipe Size Inches	Max. Diff. PSI	Type No.	Watts AC	Amps Hold 120-60	Amps Inrush 120-60	Watts DC	Ship Wt. Lbs.*	Dimensions in Inches					
								A*	B	C	D NPT	D (Flanged) 150# 300#	
1/2	110	14KR42	25	0.5	1.5	18	7	8-1/8	7	2-7/8	3-1/4	6	
	200	14KR32											
	300	29KR52	45	1.0	2.7	23	10	9-1/8	8	3-1/2		6-1/2	
3/4	110	14KR43	25	0.5	1.6	18	8	8-1/4	7-1/8	2-7/8	3-1/2	6	
	200	29KR33	45	1.0	2.9	23	12	9-1/4	8-1/8	3-1/2			6-1/2
	300	129KR53	65	1.5	4.3	33	17	10	9-1/8	7-3/4	3-1/4		6-1/2
1	110	16KR44	25	0.5	1.8	18	10	9-1/8	7-3/4	3-1/4	4-1/8	5	
	200	31KR34	45	1.0	3.0	23	14	10	8-5/8	3-1/2			6-1/2
	300	131KR54	65	1.5	4.5	33	20	11-3/8	9-1/2	4		6-1/2	
1-1/2	115	35KR46	45	1.0	3.8	23	18	11-3/8	9-1/2	4	4-7/8	6-1/2	
	200	41KR36	60	1.7	6.5	35	22	11-5/8	9-3/4	4-1/2			7-1/2
	300	141KR56	85	3.5	9.7	45	27	12-3/8	10-1/8	5-3/8		8	
2	100	36KR47	45	1.0	4.2	23	27	12-3/8	10-1/8	5-3/8	6	8	
	200	42KR37	60	1.7	7.3	35	32	12-5/8	10-3/8	5-3/8			9
	300	42KR57	85	3.5	11.0	45	32	12-5/8	10-3/8	5-3/8		9	
3	100	44KR49F1	60	1.7	8.8	35	69	14-3/8	11-1/8	6-5/8	N/A	9-1/2	N/A
	200	44KR39F1											
	300	144KR59F3	85	3.5	13.0	45	82					N/A	12-1/2

* Shipping weights and Dimension "A" apply to NPT Ends

BULLETIN 3020-W

STAINLESS STEEL Solenoid Valves

MAX. FLUID TEMP. 400° F
MAX. STATIC PRESSURE 200 PSI

TYPE W FULL PORT NORMALLY CLOSED - 1/2" to 3" PIPE SIZE
(NO DIFFERENTIAL PRESSURE REQUIRED TO OPEN)

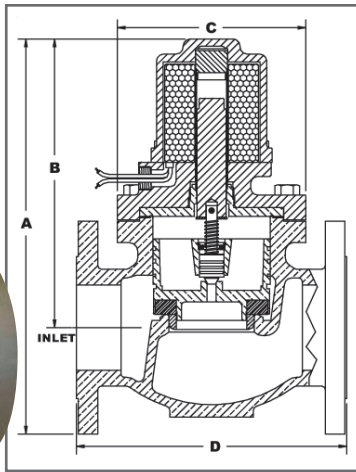
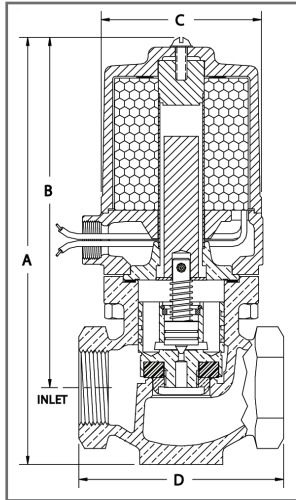

OPERATION:

Valve opens when energized and closes when de-energized. When the coil is energized the pilot valve opens, relieving the pressure above the piston, which is then lifted from its seat by the plunger. Upon de-energizing the coil, a spring closes the pilot valve and opens a bleed passageway to permit pressure to build above the piston and seat it.

CONSTRUCTION: *Wetted parts - No Copper Bearing Alloys in contact with fluid

- Valve Body* - 304 Stainless Steel Globe Pattern - NPT ends (Flanged Ends available)
- Piston* - 303 Stainless Steel
- Coil Enclosure - Malleable or Cast Iron, 1/2" NPS conduit conn.
- Plunger* - 430 Stainless Steel
- Pilot Valve* - 303 Stainless Steel
- Bonnet Tube* - 304 Stainless Steel
- Spring* - Inconel
- Body Seal* - Non Asbestos Gasket (Teflon® available)
- Orifice Seal* - Glass Filled Teflon®
- AC Shading Coil* - Silver
- Stem Pin* - Inconel
- Coil - Encapsulated Class H, 18" leads

APPLICATION:

To control the flow of **Steam**. Steam must be free of sediment. Valve operates from zero to maximum differential pressure indicated in table. Valve must be mounted in horizontal pipe with solenoid enclosure vertical and on top.

For Options and Accessories see pages 26 & 27. Strainers are recommended for use with solenoid valves (see page 19).

When ordering please supply:

- Pipe Size
- Fluid
- Valve Type
- Fluid Temperature
- Voltage (AC or DC)
- Max. Diff. Pressure
- Hertz
- Optional Features (See pages 26 & 27)

Pipe Size Inches	Max. Diff. PSI	Type No.	Watts AC	Amps Hold 120-60	Amps Inrush 120-60	Watts DC	Ship Wt. Lbs.†	Dimensions in Inches				
								A*	B	C	D	D (Flanged) 150#
1/2	90	14W22	25	0.4	1.2	18	7	7	5-7/8	2-7/8	3-1/4	6
	140	114W42	40	0.6	1.8	28	10	8	6-7/8	3-1/2		
	180	129W42	65	1.2	3.6	33						
3/4	50	14W23	25	0.4	1.3	18	8	7-1/8	6	2-7/8	3-1/2	6
	110	114W43	40	0.6	2.0	28	11	8-1/8	7	3-1/2		
	180	129W43	65	1.2	3.9	33						
1	25	16W14	25	0.4	1.5	18	10	8	6-5/8	3-1/4	4-1/8	5
	50	116W24	40	0.6	2.3	28						
	90	116W44	65	1.2	4.2	33						
1-1/2	25	35W16	45	0.8	3.2	23	17	10	8-1/8	4	4-7/8	6-1/2
	50	35W26	65	1.2	4.8	33						
	90	135W46	85	2.0	10.0	45						
2	25	36W17	45	0.8	3.5	23	27	11	8-3/4	5-3/8	6	8
	50	36W27	60	1.2	7.4	35						
	115	42W47	85	2.0	11.0	45						
3	25	44W19F1	60	1.2	8.8	35	68	13-3/4	10-1/2	6-5/8	N/A	9-1/2
	50	44W29F1	85	2.0	13.0	45						
	100	44W49F1										
	150	144W49F1										

† Shipping weights and Dimension "A" apply to NPT Ends

Shipping Weights shown here apply to Threaded Ends Only (except 3" which are Flanged Only)

For Flanged Ends contact factory for complete weight and dimensions

3" STAINLESS STEEL VALVES are SUPPLIED with FLANGED ENDS ONLY

STAINLESS STEEL Solenoid Valves



MAX. FLUID TEMP. 400° F
MAX. STATIC PRESSURE 200 PSI

TYPE WR FULL PORT NORMALLY OPEN - 1/2" to 3" PIPE SIZE
(NO DIFFERENTIAL PRESSURE REQUIRED TO OPEN)

OPERATION:

Valve closes when energized and opens when de-energized. When the coil is energized the plunger presses the poppet, closing the pilot orifice, and opens a bleed passageway to permit pressure to build above the piston and seat it. Upon de-energizing the coil, the pilot orifice is opened, relieving the pressure above the piston allowing it to leave its seat. The bottom spring allows the valve to operate at zero pressure drop.

CONSTRUCTION: *Wetted parts - No Copper Bearing Alloys in contact with fluid

- Valve Body* - 304 Stainless Steel Globe Pattern - NPT ends (Flanged Ends available)
- Piston* - 303 Stainless Steel
- Coil Enclosure - Malleable or Cast Iron, 1/2" NPS conduit conn.
- Plunger* - 430 Stainless Steel
- Poppet* - 303 Stainless Steel
- Stem* - 303 Stainless Steel
- Bonnet Tube* - 304 Stainless Steel
- Spring* - Inconel
- Body Seal* - Non Asbestos Gasket (Teflon® available)
- Orifice Seal* - Glass Filled Teflon®
- AC Shading Coil* - Silver
- Stem Pin* - 304 Stainless Steel
- Coil - Encapsulated Class H, 18" leads

APPLICATION:

To control the flow of **Steam**. Steam must be free of sediment. Valve operates from zero to maximum differential pressure indicated in table. Valve must be mounted in horizontal pipe with solenoid enclosure vertical and on top.

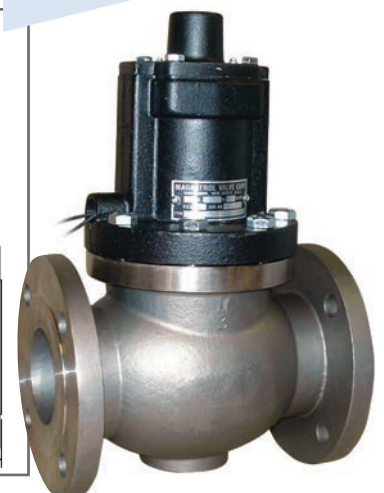
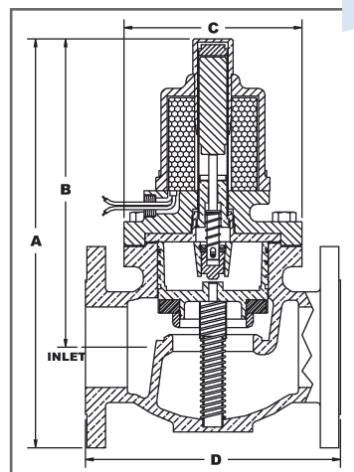
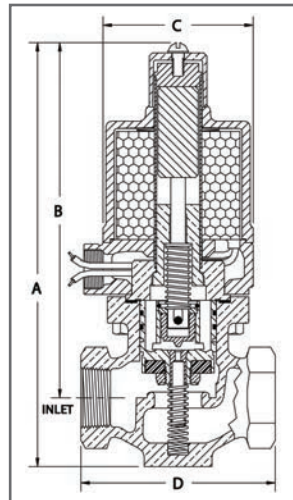

Pipe Size Inches	Max. Diff. PSI	Type No.	Watts AC	Amps Hold 120-60	Amps Inrush 120-60	Watts DC	Ship Wt. Lbs.†	Dimensions in Inches				
								A*	B	C	D	D (Flanged) 150#
1/2	90	14WR22	25	0.5	1.5	18	7	8-1/8	7	2-7/8	3-1/4	6
	140	114WR42	40	0.8	2.4	28	10	9-1/8	8	3-1/2		
	180	129WR42	65	1.5	4.2	33	12	9-1/4	8-1/8	3-1/2		
3/4	50	14WR23	25	0.5	1.6	18	8	8-1/4	7-1/8	2-7/8	3-1/2	6
	110	114WR43	40	0.8	2.6	28	12	9-1/4	8-1/8	3-1/2		
	180	129WR43	65	1.5	4.3	33	10	9-1/8	7-3/4	3-1/4		
1	25	16WR14	25	0.5	1.8	18	14	10	8-5/8	3-1/2	4-1/8	5
	50	116WR24	40	0.8	2.9	28	18	11-3/8	9-1/2	4		
	90	116WR44	65	1.5	4.5	33	22	11-5/8	9-3/4	4-1/2		
1-1/2	25	35WR16	45	1.0	3.8	23	27	12-3/8	10-1/8	5-3/8	6	8
	50	35WR26	65	1.5	5.7	33	32	12-5/8	10-3/8			
	90	135WR46	85	3.5	9.7	45	69	14-3/8	11-1/8			
2	25	36WR17	45	1.0	4.2	23	27	12-3/8	10-1/8	5-3/8	6	8
	50	36WR27	60	1.7	7.3	35	32	12-5/8	10-3/8			
	115	42WR47	85	3.5	11.0	45	69	14-3/8	11-1/8			
3	25	44WR19F1	60	1.7	8.8	35	69	14-3/8	11-1/8	6-5/8	N/A	9-1/2
	50	44WR29F1	85	3.5	13.0	45	69	14-3/8	11-1/8	6-5/8	N/A	9-1/2
	100	44WR49F1	85	3.5	13.0	45	69	14-3/8	11-1/8	6-5/8	N/A	9-1/2
150	144WR49F1	85	3.5	13.0	45	69	14-3/8	11-1/8	6-5/8	N/A	9-1/2	

† Shipping weights and Dimension "A" apply to NPT Ends

For Options and Accessories see pages 26 & 27. Strainers are recommended for use with solenoid valves (see page 19).

When ordering please supply:

- Pipe Size
- Valve Type
- Voltage (AC or DC)
- Hertz
- Fluid
- Fluid Temperature
- Max. Diff. Pressure
- Optional Features (See pages 26 & 27)

Shipping Weights shown here apply to Threaded Ends Only (except 3" which are Flanged Only)

For Flanged Ends contact factory for complete weight and dimensions

3" STAINLESS STEEL VALVES are SUPPLIED with FLANGED ENDS ONLY

OPTIONAL FEATURES

...FOR DEPENDABLE, PACKLESS SOLENOID VALVES

See Individual Options for Availability for Use with Specific Valve Types

BOTTOM MOUNTED OPTIONS **Note: Only one Bottom Mount Option can be installed on each valve**

MANUAL OVERRIDE

(Normally Closed valves only)
(Designated by Prefix "MO")
Enables manual opening of solenoid valve during power failure or to override automatic controls.

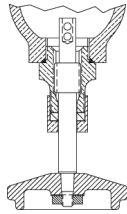

LEVER

(Normally Closed valves only)
(Designated by Prefix "LV")
Enables rapid opening of solenoid valve. Can be chain operated for use at inaccessible locations.

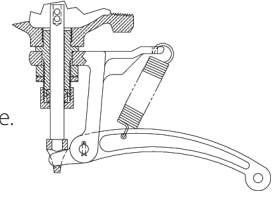

DASHPOT

(Designated by Prefix "DP")
Furnished for clean liquids to reduce water hammer effect sometimes encountered in long pipe runs by slowing valve closing.

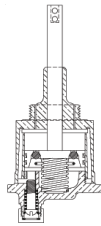

FLOW CONTROL

(Normally Closed, NR & MR valves, only)
(Designated by Prefix "FC")
Provides a manual method of reducing or throttling the flow.

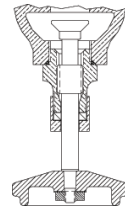

MOUNTING STUD

(Designated by Prefix "MS")
3/8"-16 thread can be furnished in bottom of body to facilitate mounting on bracket. (Not available on 2", 2-1/2" and 3")

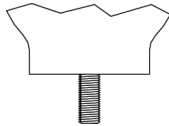

DRAIN

(Normally Closed, NR & MR valves, only)
(Designated by Prefix "DR")
1/4" NPT plug supplied in bottom of valve to facilitate draining of liquid.



OTHER OPTIONS

PILOT TAP

(Designated by Prefix "PT")
Type D, G & GR Valves can be furnished with 1/8" tapped hole for pilot connection or pressure gauge.

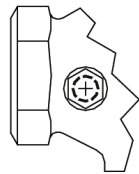

DIN CONNECTOR

(Designated by Suffix "DN")
Provides 3 prong Male connector for easy power connect / disconnect. Not available for Explosion-Proof.

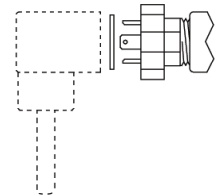

"HUM FREE": (No AC Hum/Buzz)

(Designated by Suffix "HF") – The "HUM FREE" option eliminates the "AC hum" associated with AC operated solenoid valves. Enables valves to be used where an AC hum would not be acceptable and AC is the only power source available. IE: Hospitals, labs, schools (class rooms), homes, office environments etc. & when 24 vac is required for 40 series valves.

Leak / Dead Tight:

(Normally Closed valves only)
(Designated by Suffix "LT") – The Leak / Dead Tight Option offers 'soft' resilient seating or 'gapless' seal for low pressure applications 60 PSI or less. Consult Factory for Max. Diff. Pressure and Valve Type availability.

Flanged Ends for Bronze and Stainless Steel Valves:

(Designated by Suffix "F1" for 150 lb or "F3" for 300 lb Flanges) – F1 or F3 Flanged ends available on all stainless steel valves. F1 Flanged ends available on bronze valves.

Explosion-Proof and Watertight Solenoids:

(Designated by Prefix "F") – are Explosion-proof and NEMA 4X, 7C & D, 9E, F & G suitable for use in hazardous locations requiring Class I, Div. 1 & 2, Groups C & D & Class II Groups E, F, and G equipment.

NEMA 4X:

(Designated by Prefix "E") – are suitable for use in locations requiring a NEMA 4X designation. Zinc Plating replaces the standard paint used on the Coil housing (cup and base). The additional corrosion protection satisfies NEMA 4X requirements.

Internal construction, pressure ratings, power consumption, and external dimensions are the same as for standard valves.

Nickel Plating:

(Designated by Suffix "NP") – Plating is 0.0005" Thick Meets Mil Spec. C26074

Universal Mount Valves For Mounting In Vertical Pipe Runs

(See page 28, Type "P" Valve)

POSITION INDICATORS

...FOR NORMALLY CLOSED SOLENOID VALVES

POSITION SWITCHES

CONSTRUCTION:

Housing – 316 Stainless Steel with 1/2" NPT Conduit Connection

Contact – SPDT (Single Pole/Double Throw)

Lead Wires – 36 inches long, 18 gauge standard leads potted-in PVC

OPERATION:

Switch is activated by a ferromagnetic "target" attached to the valve's piston

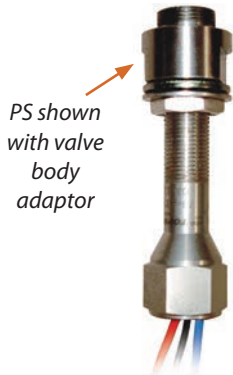

"PS" – General Purpose/NEMA 4, 4X
"PSF" – Explosion Proof

SPDT Contact

Electrical Rating:

4A @ 120 VAC / 3A @ 24 VDC

2A @ 240 VAC / 1.25A @ 48 VDC

0.5A @ 125 VDC & 250 VDC

The PS and PSF can be wired AC or DC, N/O or N/C, consume no power to operate, and leave no current leakage or voltage drop

POSITION SWITCHES with LED VISUAL INDICATION

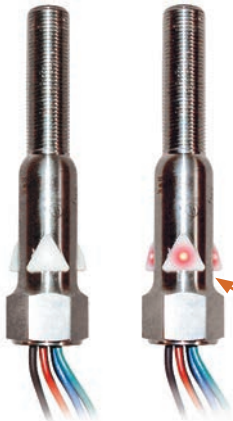

"PL" – General Purpose/NEMA 4, 4X
"PLF" – Explosion Proof

SPDT Contact

Electrical Rating:

0.25A @ 120 VAC / 24 VDC (Approx. 5V drop)

The PL and PLF can be wired AC or DC, N/O or N/C

Operating Temperature: -40°F to 160°F (71°C)

Position Switch shown here energizing Red LED

POSITION DISPLAY – VISUAL INDICATION ONLY

"PD" – General Purpose / NEMA 4, 4X / Explosion Proof

CONSTRUCTION:

Housing – Clear high-strength polycarbonate

APPLICATION:

Visual indication that valve is Open / Closed

OPERATION:

When the valve is in the closed position, a ferromagnetic "target" attached to the valve's

piston, lifts a green colored magnet into the adapter hiding it from view. When the valve is energized, (open position), the magnet drops down to a visible position.

Position Indicators for Normally Closed Valves only. Available on Type A, S, L, K, W and G Valves

HOW TO ORDER

Indicate option when ordering – Use the appropriate Prefix: PS, PSF, PL, PLF, or PD
See page 33 for Type Number details

BULLETIN
3020-POS/IND

PS General Purpose and Water Tight (SPDT Switch) shown on 3" Stainless Steel Valve below



NOTE: ONLY ONE BOTTOM MOUNTED OPTION CAN BE INSTALLED ON EACH VALVE

For multiple switches and where a switch and a bottom mounted option are required, contact our Clark-Cooper Division. (See bottom of Page 3)

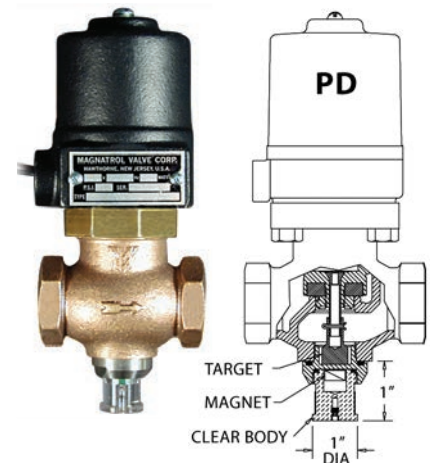

BULLETIN 3020- Universal Mount

MAX. FLUID TEMP. 212° F
MAX. STATIC PRESSURE 300 PSI



For Options and Accessories see pages 26 & 27. Strainers are recommended for use with solenoid valves (see page 19).

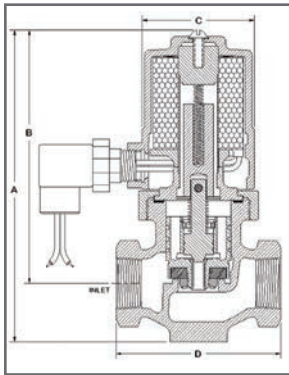

For AC
Power
Source
Shown
with "HF"
Rectifier

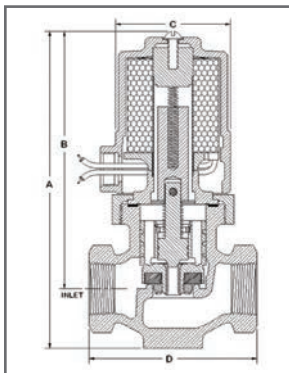

For DC
Power
Source
Drop
"HF" Suffix,
i.e. 118P44

When ordering please supply:

- Pipe Size
- Valve Type
- Voltage (AC or DC)
- Hertz
- Fluid
- Fluid Temperature
- Max. Diff. Pressure
- Optional Features (See pages 26 & 27)

BRONZE Solenoid Valves

TYPE P FULL PORT NORMALLY CLOSED - 1/2" to 1-1/2" PIPE SIZE
(NO DIFFERENTIAL PRESSURE REQUIRED TO OPEN)

OPERATION:

Valve opens when energized and closes when de-energized. When the coil is energized the pilot valve opens, relieving the pressure above the piston, which is then lifted from its seat by the plunger. Upon de-energizing the coil, a spring closes the pilot valve and opens a bleed passageway to permit pressure to build above the piston and seat it.

CONSTRUCTION: * Wetted parts

- Valve Body* - Cast Bronze, Globe Pattern - NPT ends (Flanged Ends available)
- Piston* - Bronze
- Coil Enclosure - Malleable Iron, 1/2" NPS conduit conn.
- Plunger* - 430 Stainless Steel
- Plunger Spring* - 304 Stainless Steel
- Pilot Valve* - 303 Stainless Steel
- Bonnet Tube* - 304 Stainless Steel
- Spring* - 302 Stainless Steel
- Body Seal* - Buna N or Non Asbestos Gasket (Viton® or Teflon® available)
- Orifice Seal* - Buna N (Viton® or Glass-filled Teflon® available)
- Stem Pin* - Inconel
- Coil - Encapsulated Class H, 18" leads

The "P" Valve is Multiposited:

Able to be mounted in any position

Spring-Loaded:

The term used to indicate that the valve has a plunger spring. A spring-loaded plunger permits the valve to be mounted in any position without causing malfunction.

APPLICATION:

To control the flow of Water, Oil, Air, Gas, Solvents, Brine, Vacuum and any other fluids not reactive with construction materials and free of sediment. Valve operates from zero to maximum differential pressure indicated in table. Valve can be mounted in ANY POSITION (See box above).

For "P" Valve design feature for Stainless Steel valves consult the factory

Pipe Size Inches	Max. Diff. PSI	Type No.	Watts DC	Ship Wt. Lbs.	Dimensions in Inches			
					A	B	C	D
1/2	110	118P42HF	28	8	7	5-7/8	2-3/4	3-1/4
	200	118P32HF						
	300	118P52HF						
3/4	50	118P23HF	28	8	7-1/2	6	2-3/4	3-1/2
	110	118P43HF						
	200	133P33HF	33	12	8-1/8	7	4-1/8	
	300	133P53HF						
1	50	118P24HF	28	10	7-7/8	6-5/8	2-3/4	4-1/8
	110	118P44HF						
	200	133P34HF	33	14	8-7/8	7-1/2	3-1/2	
	300	133P54HF						
1-1/2	115	41P46HF	35	24	11	9-1/8	4-1/2	4-7/8
	200	41P36HF						
	300	41P56HF						

Explosion Proof: Available for DC Power Source **ONLY**
(Valves without "HF" suffix use Prefix "F", i.e. F118P44)

BRONZE Solenoid Valves

**BULLETIN 3020-
Sandy Well Water**

**SANDY
WELL
WATER**

FULL PORT NORMALLY CLOSED - 1/2" to 3" PIPE SIZE

(NO DIFFERENTIAL PRESSURE REQUIRED TO OPEN)

OPERATION:

Valve opens when energized and closes when de-energized. When the coil is energized the pilot valve opens, relieving the pressure above the piston, which is then lifted from its seat by the plunger. Upon de-energizing the coil, a spring closes the pilot valve and opens a bleed passageway to permit pressure to build above the piston and seat it.

CONSTRUCTION: *Wetted parts

- Valve Body* – Cast Bronze, Globe Pattern – NPT ends (**Flanged Ends available**)
- Piston* – Bronze
- Coil Enclosure – Malleable or Cast Iron, 1/2" NPS conduit conn.
- Plunger* – 430 Stainless Steel
- Pilot Valve* – 303 Stainless Steel
- Bonnet Tube* – 304 Stainless Steel
- Spring* – 302 Stainless Steel
- Body Seal* – Buna N or Non Asbestos Gasket (**Viton® or Teflon® available**)
- Orifice Seal* – Buna N (**Viton® or Glass Filled Teflon® available**)
- AC Shading Coil* – Copper
- Stem Pin* – Inconel
- Coil – Encapsulated Class B, 18" leads – (Class H available)

APPLICATION:

To control the flow of **Sandy Well Water**, the valve is designed with the piston and other components "turned down", offering additional clearance, allowing the valve to operate with fluids containing some sediment typically found in well water. Valve operates from zero to maximum differential pressure indicated in table. Valve must be mounted in horizontal pipe with solenoid enclosure vertical and on top.

Pipe Size Inches	Max. Diff. PSI	Type No.	Watts AC	Watts DC	Ship Wt. Lbs.	Dimensions in Inches			
						A	B	C	D
1/2	50	18A22-V	25	18	8	7	5-7/8	2-3/4	3-1/4
	80	118A22-V	40	28					
3/4	50	18A23-V	25	18	8	7-1/8	6	2-3/4	3-1/2
	75	118A23-V	40	28					
	125	233A23-V	80	40					
1	50	18A24-V	25	18	10	7-7/8	6-5/8	2-3/4	4-1/8
	75	118A24-V	40	28					
	125	133A24-V	65	33					
	200	233A24-V	80	N/A					
1-1/4	50	18A25-V	25	18	12	8-3/8	6-3/4	2-3/4	4-1/2
	75	118A25-V	40	28					
	110	133A25-V	65	33					
	300	140A45-V	85	N/A					
1-1/2	50	35A26-V	45	23	20	10	8-1/8	4	4-7/8
	75	135A26-V	65	33					
	125	41A26-V	60	35					
2	30	36A17-V	45	23	31	11	8-3/4	5-3/8	6
	50	136A17-V	65	33					
	75	136A27-V	65	33					
	125	42A27-V	60	35					
	185	142A27-V	85	45					
2-1/2	30	43A18-V	60	35	43	12-7/8	10-1/8	5-7/8	7-1/4
	50	143A18-V	85	45					
	75	243A18-V	115	65					
3	30	44A19-V	60	35	56	13-3/4	10-1/2	6-5/8	8-3/8
	50	144A19-V	85	45					
	75	244A19-V	115	65					

MAX. FLUID TEMP. 212° F
MAX. STATIC PRESSURE 300 PSI



For Options and Accessories see pages 26 & 27. Strainers are recommended for use with solenoid valves (see page 19).

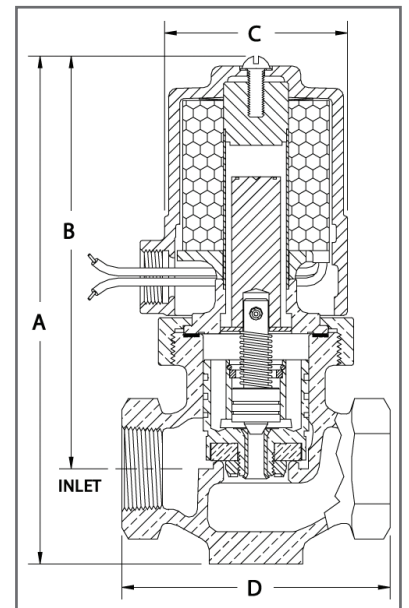

When ordering please supply:

- Pipe Size
- Valve Type
- Voltage (AC or DC)
- Hertz
- Fluid
- Fluid Temperature
- Max. Diff. Pressure
- Optional Features (See pages 26 & 27)

BULLETIN 3020- Gritty Coolant

MAX. FLUID TEMP. 212° F
MAX. STATIC PRESSURE 300 PSI



For Options and Accessories see pages 26 & 27. Strainers are recommended for use with solenoid valves (see page 19).

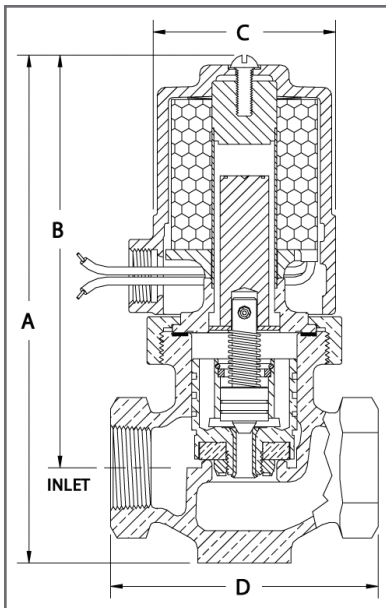

When ordering please supply:

- Pipe Size
- Valve Type
- Voltage (AC or DC)
- Hertz
- Fluid
- Fluid Temperature
- Max. Diff. Pressure
- Optional Features (See pages 26 & 27)

BRONZE Solenoid Valves

GRITTY COOLANT

FULL PORT NORMALLY CLOSED - 1/2" to 1-1/2" PIPE SIZE
(NO DIFFERENTIAL PRESSURE REQUIRED TO OPEN)

OPERATION:

Valve opens when energized and closes when de-energized. When the coil is energized the pilot valve opens, relieving the pressure above the piston, which is then lifted from its seat by the plunger. Upon de-energizing the coil, a spring closes the pilot valve and opens a bleed passageway to permit pressure to build above the piston and seat it.

CONSTRUCTION: *Wetted parts

- Valve Body* – Cast Bronze, Globe Pattern – NPT ends (Flanged Ends available)
- Piston* – Bronze
- Coil Enclosure – Malleable or Cast Iron, 1/2" NPS conduit conn.
- Plunger* – 430 Stainless Steel
- Pilot Valve* – 303 Stainless Steel
- Bonnet Tube* – 304 Stainless Steel
- Spring* – 302 Stainless Steel
- Body Seal* – Buna N or Non Asbestos Gasket (Viton® or Teflon® available)
- Orifice Seal* – Buna N (Viton® or Glass Filled Teflon® available)
- AC Shading Coil* – Copper
- Stem Pin* – Inconel
- Coil – Encapsulated Class B, 18" leads – (Class H available)

APPLICATION:

To control the flow of **Coolant**, the valve is designed with the piston "turned down", and a larger pilot port, offering additional clearance, allowing the valve to operate with fluids containing some grit/sediment typically found in coolant. Valve operates from zero to maximum differential pressure indicated in table. Valve must be mounted in horizontal pipe with solenoid enclosure vertical and on top.

Pipe Size Inches	Max. Diff. PSI	Type No.	Watts AC	Watts DC	Ship Wt. Lbs.	Dimensions in Inches			
						A	B	C	D
1/2	80	MS18A42-C	25	18	8	7	5-7/8	2-3/4	3-1/4
	200	MS33A22-C	40	23					
	300	MS233A42-C	80	40					
3/4	80	MS18A43-C	25	18	8	7-1/8	6	2-3/4	3-1/2
	125	MS33A23-C	45	23					
	200	MS133A23-C	65	33					
	300	MS233A43-C	80	40					
1	200	MS233A24-C	80	40	10	7-7/8	6-5/8	2-3/4	4-1/8
	300	MS233A44-C	80	40					
1-1/4	200	MS233A25-C	80	40	12	8-3/8	6-3/4	2-3/4	4-1/2
	300	MS233A45-C	80	40					
1-1/2	300	MS241A46-C	115	65	20	10	8-1/8	4	4-7/8

"A" Dimension does not include the "MS" Mounting Stud (approx. 7/8")

Note: The addition of any bottom mounted option would replace the "MS" Mounting Stud and change the prefix to reflect the appropriate option.

BRONZE Solenoid Valves

GRITTY COOLANT

FULL PORT NORMALLY OPEN - 1/2" to 1" PIPE SIZE

(NO DIFFERENTIAL PRESSURE REQUIRED TO OPEN)

OPERATION:

Valve closes when energized and opens when de-energized. When the coil is energized the plunger presses the poppet, closing the pilot orifice, and opens a bleed passageway to permit pressure to build above the piston and seal it. Upon de-energizing the coil, the pilot orifice is opened, relieving the pressure above the piston, allowing it to leave its seat. The bottom spring allows the valve to operate at zero pressure drop.

CONSTRUCTION: *Wetted parts

- Valve Body* – Cast Bronze, Globe Pattern – NPT ends (Flanged Ends available)
- Piston* – Cast Bronze
- Coil Enclosure – Malleable or Cast Iron, 1/2" NPS conduit conn.
- Plunger* – 430 Stainless Steel
- Poppet* – 303 Stainless Steel
- Stem* – 303 Stainless Steel
- Bonnet Tube* – 304 Stainless Steel
- Springs* – Inconel and 302 Stainless Steel
- Body Seal* – Buna N or Non Asbestos Gasket (Viton® or Teflon® available)
- Orifice Seal* – Buna N (Viton® or Glass Filled Teflon® available)
- AC Shading Coil* – Copper
- Stem Pin* – 304 Stainless Steel
- Coil – Encapsulated Class B, 18" leads (Class H available)

APPLICATION:

To control the flow of **Coolant**, the valve is designed with the piston "turned down", and a larger pilot port, offering additional clearance, allowing the valve to operate with fluids containing some grit/sediment typically found in coolant. Valve operates from zero to maximum differential pressure indicated in table. Valve must be mounted in horizontal pipe with solenoid enclosure vertical and on top.

Pipe Size Inches	Max. Diff. PSI	Type No.	Watts AC	Watts DC	Ship Wt. Lbs.	Dimensions in Inches			
						A	B	C	D
1/2	200	MS33AR42-C	45	23	8	9-3/8	8-1/4	4-1/8	3-1/4
	50	MS18AR23-C	25	18	9	8-1/4	7-1/8	2-3/4	3-1/2
3/4	110	MS233AR43-C	80	40	13	9-1/4	8-1/8	3-1/2	3-1/2
	110	MS33AR44-C	45	23					
1	200	MS233AR24-C	80	40	14	10	8-5/8	3-1/2	4-1/8
	300	MS233AR44-C	80	40					

"A" Dimension does not include the "MS" Mounting Stud (approx. 7/8")

Note: The addition of any bottom mounted option would replace the "MS" Mounting Stud and change the prefix to reflect the appropriate option.

**BULLETIN 3020-
Gritty Coolant**

MAX. FLUID TEMP. 212° F

MAX. STATIC PRESSURE 300 PSI



For Options and Accessories see pages 26 & 27. Strainers are recommended for use with solenoid valves (see page 19).

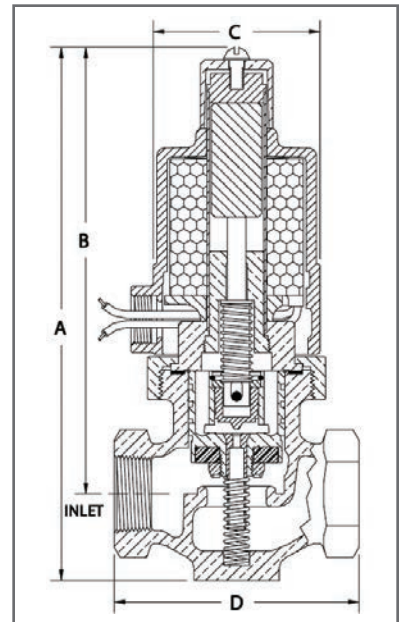

When ordering please supply:

- Pipe Size
- Valve Type
- Voltage (AC or DC)
- Hertz
- Fluid
- Fluid Temperature
- Max. Diff. Pressure
- Optional Features (See pages 26 & 27)



REQUEST A QUOTE

...PLEASE FILL IN THE INFORMATION BELOW

We appreciate the opportunity to quote on your requirements

For immediate quote – Call 973-427-4341 with the information below
For same day quote – Fax the information below to 973-427-7611 or e-mail to info@magnatrol.com
Request a quote online at – www.magnatrol.com, and click on Quick Quote

If you have any questions, please call 973-427-4341, Fax 973-427-7611, or e-mail info@magnatrol.com

YOUR COMPANY DATA

Company Name: _____ **Phone:** _____
Contact (Your Name): _____ **Fax:** _____
Your RFQ Reference (If Any): _____
Type of Business: OEM Re-Seller Consumer/End User
E-Mail: _____

VALVE DATA

Desired Delivery: _____ **Quantity:** _____
Your Reference (Optional): _____
Valve Construction Material: Bronze or Stainless Steel
Pipe Size: (3/8" thru 3"): _____
Normally: **Closed** (Energize To Open) or **Open** (Energize To Close)
Voltage: **AC:** _____ Volts/ _____ Hz or **DC:** _____ Volts
Maximum Differential Pressure: _____ PSI
Fluid: _____
Maximum Fluid Temperature: _____ °F
Optional Feature: (See Optional Feature Details On Pages 26 & 27)
 Choose One (1) of the following per valve: MO LV DP FC MS DR PD PS PL
Additional Options: (Can be combined with one (1) of the above Optional Features) HF LT NP PT DN ZP
Enclosure Options: General Purpose Explosion Proof NEMA 4X
 (For Solenoid Housing) (Prefix "G" - NEMA 12) (Prefix "F") (Prefix "E")
Comments: _____

Quantity Discounts: Consult Factory
Delivery: Most orders ship in 7-10 days. Small emergency orders can be shipped in 1-2 days.

ORDERING GUIDELINES



...FOR MAGNATROL SOLENOID VALVES

MAGNATROL VALVE TYPE NUMBER DETAIL

For additional information on Options – See Optional Features pages 26 & 27

If you have any questions, please call 973-427-4341, Fax 973-427-7611, or e-mail info@magnatrol.com

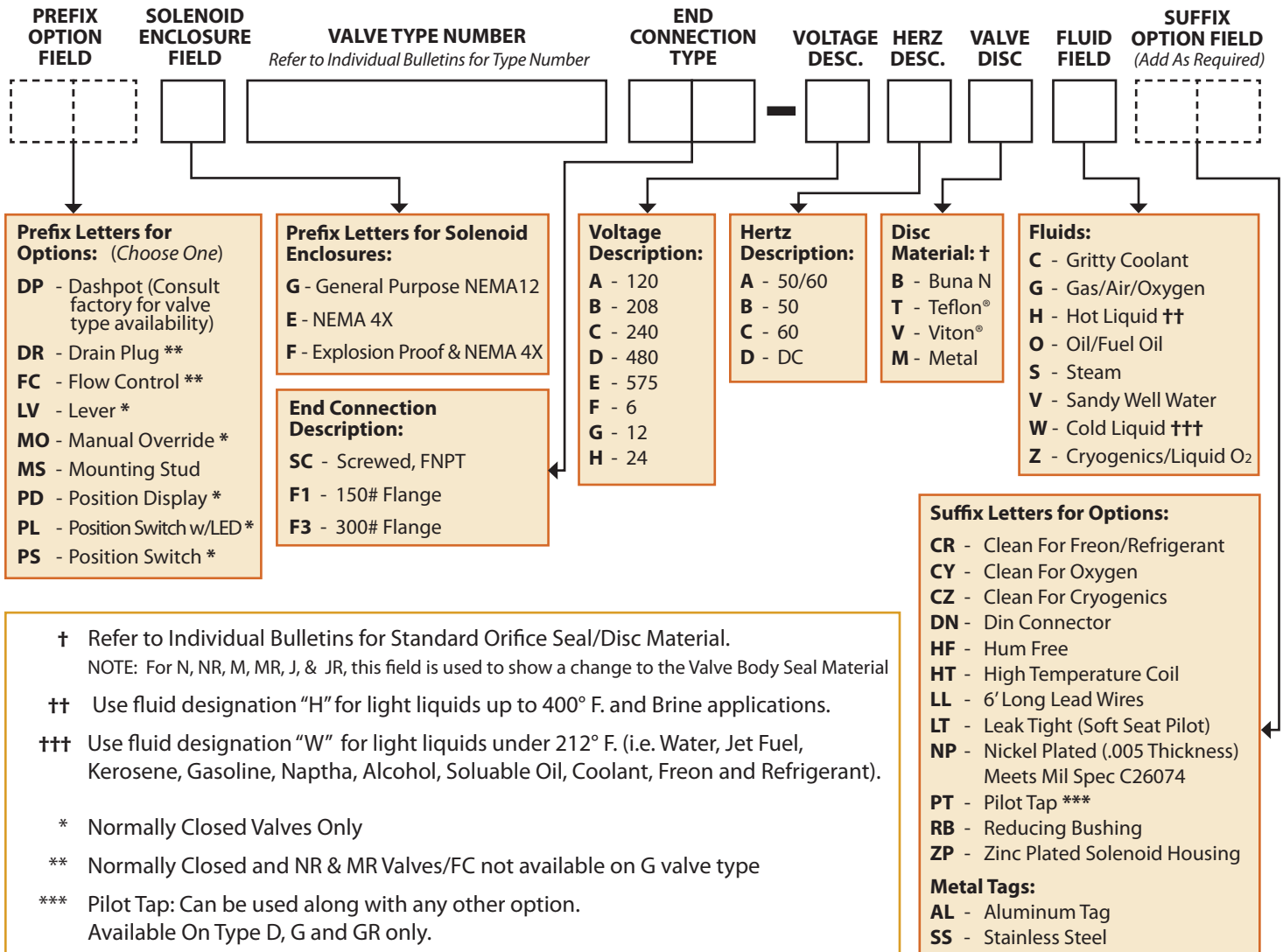

Consult Factory for Assistance with:

- Additional voltages
- End Connections not shown
- Fluid Field designations

TERMS & CONDITIONS OF SALE

Solenoid valve questions can be answered quickly and accurately over the phone:
Phone: 973-427-4341 • Fax: 973-427-7611

TERMS AND CONDITIONS OF SALE

- 1. Catalog:** This catalog supersedes all previous issues.
- 2. Quotations:** Quotations are made for acceptance within 60 days and are subject to change or withdrawal without notice.
- 3. Prices and Discounts:** All prices and discounts are in accordance with the prices and discounts established by Magnatrol and are subject to change without notice.
- 4. Terms:** Net 30 days, subject to establishment of credit.
- 5. Shipments:** All shipments are F.O.B. factory, Hawthorne, New Jersey. Our responsibility ends with delivery of merchandise to the transportation company and issuance to us of formal shipping receipt.
- 6. Minimum Billing:** Minimum billing charge is \$50.00 net.
- 7. Cancellations:** Orders are subject to cancellation only with our consent.
- 8. Shipping Date:** There shall be no liability for default or delay in shipping. All orders, contracts, and agreements are made subject to delays contingent upon accidents, strikes, embargoes or other causes beyond our control.
- 9. Design and Materials:** All materials and designs are subject to change without notice.
- 10. Weights and Dimensions:** Weights and dimensions listed in this catalog are as close to actual as is practicable but are not guaranteed and are subject to change without notice.
- 11. Errors:** All clerical errors are subject to correction.
- 12. Returns for Repair:** Valves returned for repair must be shipped prepaid and accompanied by a detailed report regarding service application, installation and nature of trouble or malfunction.
- 13. Returns for Credit:** Returns for credit will be accepted only with our consent. Credit will be subject to restocking charge and any additional expenses incurred in restoring valves to salable condition. Credit will be issued only to original purchaser.
- 14. Taxes:** Any manufacturer's excise tax, use tax, sales tax or tax or duty of any nature shall be paid by the buyer. In the event that the seller is required to pay any such taxes or duties, the buyer shall reimburse seller therefore. The buyer may provide seller with an exemption certificate or other documents acceptable to taxing or customs authorities at the time an order is placed.
- 15. Guarantee:** MAGNATROL valves are guaranteed to be free from any defects in material and workmanship for one year or 500,000 cycles, whichever comes first. Our guarantee solely conveys the right to repair or replace free of charge, any defective valves, or parts, thereof, returned to us transportation charges prepaid, within one year after date of original shipment from factory.
This guarantee shall not apply if the valve has been:
 - Improperly Installed
 - Used for other than intended service
 - Repaired without authorization



Magnatrol Contact Information

Sales, Service, Tech Support:	Phone: 973-427-4341 Fax: 973-427-7611 Email: info@magnatrol.com techsupport@magnatrol.com
Mailing Address:	PO Box 17 Hawthorne, NJ 07507
Shipping Address:	21 Horton Avenue Hawthorne, NJ 07506
Administrative:	67 Fifth Avenue Hawthorne, NJ 07506



MAGNATROL VALVE CORPORATION

67 Fifth Avenue • Hawthorne, NJ 07506
973.427.4341 • info@magnatrol.com • www.magnatrol.com