

TEL-TRU
ROCHESTER, NY, USA

**For Ray™
Pressure
Snubbers
there's only
one place
to go.**



Tel-Tru Manufacturing Co.

A Simple, Cost-Effective Solution to Damaging Pressure Surges And Shocks

Through its unique design, the RAY SNUBBER'S™ rugged piston moving within its chamber kicks out the sediment and pipe scale that clog needle valves, filters, porous metal discs and other designs.

There is a RAY SNUBBER™ for every application:

- Brass, Stainless Steel, Aluminum or Monel construction
- Pressure ratings from vacuum to 20,000 psi (up to 60,000 psi with special high pressure connections)
- Air, Water, Gases, Petrochemicals
- British taper threads or American NPT
- 104 models in stock featuring 12 piston options

To accommodate variations in viscosities, every snubber is delivered with three different-sized easily changed pistons. And because the piston is the only moving part, maintenance is minimal. No parts to be regularly cleaned or replaced.

C E N T E R J O I N T S N U B B E R

Preferred for Non-Repetitive Installation
Center Joint Allows Easy Piston Changing.

MODEL 010

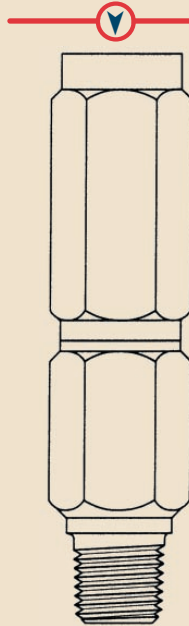

MODEL NO.	CONNECTIONS INLET	CONNECTIONS OUTLET	BODY MTRL	MAX. PSI	LN.	HEX
010B			Brass	3000	3.46	.750
010S	1/4 NPT	1/4 NPT	303 Stainless	5000		
010SS			316 Stainless	5000		

Available in British Taper Pipe Threads: Add BPS to part number.

MODEL 050

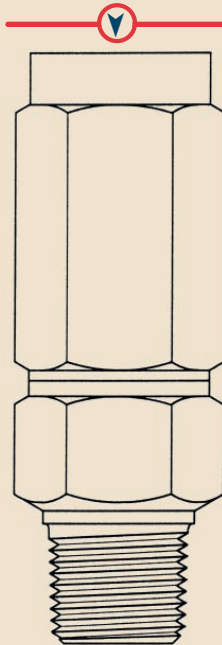

MODEL NO.	CONNECTIONS INLET	CONNECTIONS OUTLET	BODY MTRL	MAX. PSI	LN.	HEX
050B	3/8 NPT	3/8 NPT	Brass	5000	3.61	1.125

Available in British Taper Pipe Threads: Add BPS to part number.

MODEL 060

MODEL NO.	CONNECTIONS INLET	CONNECTIONS OUTLET	BODY MTRL	MAX. PSI	LN.	HEX
060B			Brass	5000	3.61	1.125
060S	1/2 NPT	1/2 NPT	303 Stainless	10,000		
060SS			316 Stainless	10,000		

Available in British Taper Pipe Threads: Add BPS to part number.

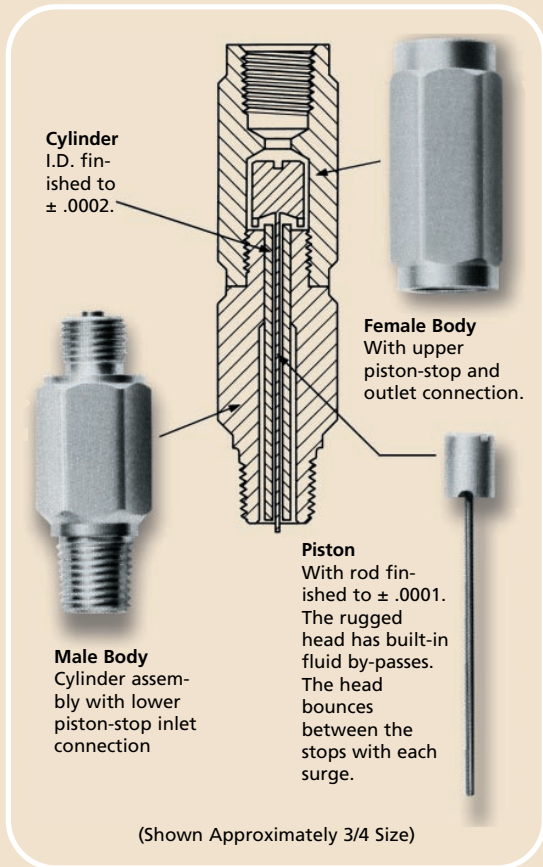

Product drawings shown at approximately 3/4 size

Ideal for OEM market. While pistons can be changed, product quality and uniformity make it unnecessary.

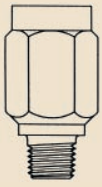

MODEL 047

MODEL NO.	CONNECTIONS		BODY MTRL	MAX. PSI	LN.	HEX
	INLET	OUTLET				
047B			Brass	3000		
047S	1/8 NPT	1/8 NPT	303 Stainless	5000	1.5	.688
047SS			316 Stainless	5000		

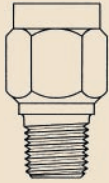

MODEL 022

MODEL NO.	CONNECTIONS		BODY MTRL	MAX. PSI	LN.	HEX
	INLET	OUTLET				
022B			Brass	5000		
022M	1/4 NPT	1/4 NPT	Monel (Nickel-Copper)	5,000	1.5	.75
022S			303 Stainless	15,000		
022SS			316 Stainless	15,000		

Available in British Taper Pipe Threads: Add BPS to part number.

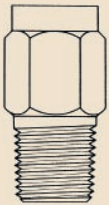

MODEL 104

MODEL NO.	CONNECTIONS		BODY MTRL	MAX. PSI	LN.	HEX
	INLET	OUTLET				
104S	3/8 NPT	1/4 NPT	303 Stainless	10,000	1.69	.75

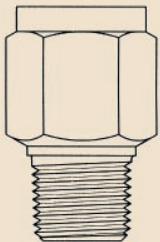

MODEL 023

MODEL NO.	CONNECTIONS		BODY MTRL	MAX. PSI	LN.	HEX
	INLET	OUTLET				
023B			Brass	5000		
023M	1/2 NPT	1/2 NPT	Nickel-Copper (Monel)	5,000	2	1.125
023S			303 Stainless	15,000		
023SS			316 Stainless	15,000		

Available in British Taper Pipe Threads: Add BPS to part number.

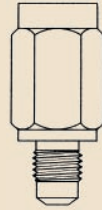

MODEL 095

MODEL NO.	CONNECTIONS		BODY MTRL	MAX. PSI	LN.	HEX
	INLET	OUTLET				
095B	1/4 Tube	1/8 NPT	Brass	3000	1.75	.688

Tube angle is 37° with 7/16-20 threads.

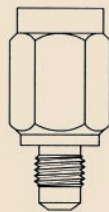

MODEL 078

MODEL NO.	CONNECTIONS		BODY MTRL	MAX. PSI	LN.	HEX
	INLET	OUTLET				
078B	1/4 Tube	1/4 NPT	Brass	3000	1.75	.75
078S			303 Stainless	5000		

Tube angle is 37° with 7/16-20 threads.

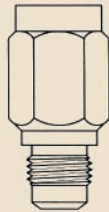

MODEL 108

MODEL NO.	CONNECTIONS		BODY MTRL	MAX. PSI	LN.	HEX
	INLET	OUTLET				
108B	3/8 Tube	1/4 NPT	Brass	3000	1.75	.75

Tube angle is 37° with 9/16-18 threads.

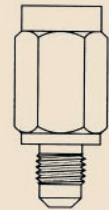

MODEL 125

MODEL NO.	CONNECTIONS		BODY MTRL	MAX. PSI	LN.	HEX
	INLET	OUTLET				
125B	1/4 Tube	1/8 NPT	Brass	3000	1.75	.688

Tube angle is 45° with 7/16-20 threads.

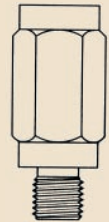

MODEL 055

MODEL NO.	CONNECTIONS		BODY MTRL	MAX. PSI	LN.	HEX
	INLET	OUTLET				
055M	1/4 Tube	O-Ring Seal	Monel	6000	1.85	.688
055SS			316 Stainless	6000		

Inlet is to MS33514-4 & SAE J514, commonly called flareless bite type. Outlet is to MS16142. Both threads are 7/16-20. Nuts, ferrules &/or O-Rings must be ordered separately.

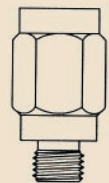

MODEL 039

MODEL NO.	CONNECTIONS		BODY MTRL	MAX. PSI	LN.	HEX
	INLET	OUTLET				
039B	O-Ring Seal	O-Ring Seal	Brass	3000		
039M			Monel	6000	1.5	.688
039SS	1/4 Tube	1/4 Tube	316 Stainless	6000		

Outlet is to MS16142. Both threads are 7/16-20. O-Rings are available.

To accommodate variations in viscosities, every snubber is delivered with three different-sized easily changed pistons.

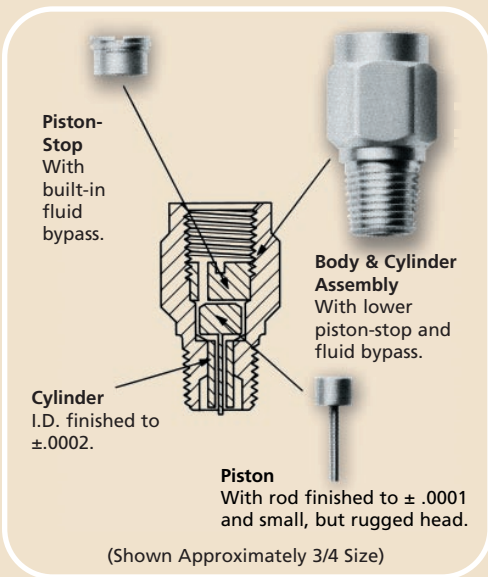

RAY™ POROUS METAL PRESSURE SNUBBERS

A Simple, Cost-Effective Solution to Protecting Valuable Control Instruments...

- Stop shocks and pulsations that damage pressure instruments
- Cut cost of maintenance, calibration, and repair
- Assure accuracy of instruments and readings
- Prevent false operation of control equipment
- Increase life of instruments

AVAILABLE IN THE FOLLOWING POROSITIES AND END CONNECTIONS:

Body Type	Material	Maximum PSI	Light Oil & Water "E" Porosity	Air, Steam & Gas "G" Porosity
1/4" NPT Length: 1.5" Weight: 2 oz.	Brass	5,000	722BE	722BG
	303 Stainless	15,000	722SE	722SG
1/2" NPT Length: 2.2" Weight: 8 oz.	Brass	5,000	723BE	723BG
	303 Stainless	15,000	723SE	723SG



OTHER PRODUCTS AVAILABLE FROM TEL-TRU



BIMETAL THERMOMETERS

THERMOWELLS
DIAPHRAGM SEALS
GAS ACTUATED THERMOMETERS
VAPOR TENSION THERMOMETERS
GLASS INDUSTRIAL THERMOMETERS
SURFACE THERMOMETERS
DIGITAL THERMOMETERS
NON-CONTACT THERMOMETERS



PRESSURE GAUGES



Tel-Tru Manufacturing Company

408 St. Paul St., Rochester NY 14605

Phone: 716-232-1440 • 800-232-5335 • Fax: 716-232-3857 • E-mail: info@teltru.com • Web: <http://www.teltru.com>

Catalog RPS97